



ASSEMBLY TOOLS AND SYSTEMS



Torque and Angle control Tools



The MD series is a complete line of Torque and Angle control tightening tools developed with productivity and manufacturing quality in mind.

Productivity :

- Self-learning mode determines the best parameters to provide with the best torque accuracy with the highest possible speed.
- Lowest MTBF thank to its high quality DC brushless motor.

Manufacturing Quality :

- Extreme torque accuracy (+/-3%) thanks to innovative shut off management (Torque rising time - Torque holding time) according to joint features.
- All errors checked thanks to Poka Yoke functions and AC/TM - TC/AM tightening strategies.



Straight Screwdrivers from 0,03 to 49 Nm – Lever start



Pistol screwdrivers from 0,1 to 49 Nm – Trigger start – handle or top exit cable



Angle nutrunners from 0.2 to 49 Nm



Fixtured spindle for automation 0.01 to 49 Nm (Remote start through I/O of the controller)

Torque and Angle control Tools



- Page 5 • Straight screwdrivers from 0,03 to 49 Nm
MD Series
- Page 6 • Pistol screwdrivers from 0,1 to 49 Nm
MDP Series
- Page 7 • Angle nutrunners from 0,2 to 49 Nm
MDH Series
- Page 8 • Fixtured spindle for automation 0,01 to 49 Nm
MDA Series
- Page 9 • Controllers
MDC Series
- Page 13 • Software
- Page 14 & 15 • Accessories





MD Series

Main features



- 15 tightening programs (torque and angle control)
- 2 multi sequences programs
- 15 sequencing Models of 10 steps with assignable tightening strategies, batch counting. Logical I/O management.
- Color LCD touch screen with user friendly graphical interface
- Automatic adjustment of speed
- Self learning mode for optimization of tightening parameters
- Error code display
- Free PC software for programming and real time monitoring
- Tightening curve display in real time
- Real time fastening data output
- RS232C and Ethernet communication ports
- Modbus protocol (TCP/IP, RTU)
- Results recording on SD card for traceability (optional)
- 10% torque accuracy in full scale and +/- 3% of repeatability
- Statistical analysis of results (Stdev, Mean, Average, Cp, Cpk) on PC software
- 8 inputs and 8 outputs assignable digital I/O
- ESD free by conductive body grounding
- Long life time over 5 million cycles

MD Series

Straight screwdrivers from 0,03 to 49 Nm



Model	Torque (Nm)	Speed range (rpm)	Drive	Weight (g)	Suitable Controller	Code
MD2601-A	0.03 – 0.39	150 - 2000	Hex1/4"	430 g	MDC-26	6-1050500
MD2601-E	0.03 – 0.39	150 - 2000	Half moon	430 g	MDC-26	6-1050501
MD2602-A	0.05 – 0.68	150 - 2000	Hex1/4"	435 g	MDC-26	6-1050502
MD2602-E	0.05 – 0.68	150 - 2000	Half moon	435 g	MDC-26	6-1050503
MD2604-A	0.2 – 1.37	150 - 1500	Hex1/4"	515 g	MDC-26	6-1050504
MD2611-A	0.4 – 3.3	100 - 900	Hex1/4"	545 g	MDC-26	6-1050505
MD2616-A	0.5 – 4.9	100 - 620	Hex1/4"	545 g	MDC-26	6-1050506
MD3201-A	0.1 – 1.17	150 - 2000	Hex1/4"	675 g	MDC-32	6-1050507
MD3202-A	0.2 – 2.15	150 - 2000	Hex1/4"	685 g	MDC-32	6-1050508
MD3204-A	0.4 – 3.9	150 - 1500	Hex1/4"	850 g	MDC-32	6-1050509
MD3211-A	1 – 8.8	50 - 690	Hex1/4"	910 g	MDC-32	6-1050510
MD3216-A	2 – 13.7	50 - 470	Hex1/4"	905 g	MDC-32	6-1050511
MD3236-Q	4 – 27	50 - 210	SQ3/8"	1340 g	MDC-32	6-1050512
MD3264-Q	8 – 49	50 - 115	SQ1/2"	1330 g	MDC-32	6-1050513

Delivered without tool cable.

Model	Code
Cable MD 3 m	6-1050582
Cable reinforced MD 3 m	6-1050583
Cable MD 5 m	6-1050584
Cable reinforced MD 5 m	6-1050585





MDP Series

Pistol screwdrivers from 0,1 to 49 Nm



Model	Torque (Nm)	Speed range (rpm)	Drive	Weight (g)	Suitable Controller	Code
MDP3201-A/U	0.1 - 1.17	150 - 2000	Hex1/4"	735 g	MDC-32	6-1050514
MDP3201-A/D	0.1 - 1.17	150 - 2000	Hex1/4"	735 g	MDC-32	6-1050515
MDP3202-A/U	0.2 - 2.15	150 - 2000	Hex1/4"	745 g	MDC-32	6-1050516
MDP3202-A/D	0.2 - 2.15	150 - 2000	Hex1/4"	745 g	MDC-32	6-1050517
MDP3204- A/U	0.4 - 3.9	150 - 1500	Hex1/4"	910 g	MDC-32	6-1050518
MDP3204- A/D	0.4 - 3.9	150 - 1500	Hex1/4"	910 g	MDC-32	6-1050519
MDP3211-A/U	1 - 8.8	50 - 690	Hex1/4"	970 g	MDC-32	6-1050520
MDP3211-A/D	1 - 8.8	50 - 690	Hex1/4"	970 g	MDC-32	6-1050521
MDP3216-A/U	2 - 13.7	50 - 470	Hex1/4"	965 g	MDC-32	6-1050522
MDP3216-A/D	2 - 13.7	50 - 470	Hex1/4"	965 g	MDC-32	6-1050523
MDP3236-Q/U	4 - 27	50 - 210	SQ3/8	1400 g	MDC-32	6-1050524
MDP3236-Q/D	4 - 27	50 - 210	SQ3/8	1400 g	MDC-32	6-1050525
MDP3264-Q/U	8 - 49	50 - 115	SQ1/2	1410 g	MDC-32	6-1050526
MDP3264-Q/D	8 - 49	50 -115	SQ1/2	1410 g	MDC-32	6-1050527

** MDP32xx-A/U – Top exit cable connector MDP32xx-A/D – Handle cable connector
Delivered without tool cable.

Model	Code
Cable MD 3 m	6-1050582
Cable reinforced MD 3 m	6-1050583
Cable MD 5 m	6-1050584
Cable reinforced MD 5 m	6-1050585



MDH Series

Angle nutrunners from 0,2 to 49 Nm



Model	Torque (Nm)	Speed range (rpm)	Bit socket	Weight (g)	Suitable Controller	Code
MDH2604-A	0.2 - 1.37	150 - 1500	Hex1/4"	875 g	MDC-26	6-1050528
MDH2611-A	0.4 - 3.3	100 - 900	Hex1/4"	905 g	MDC-26	6-1050529
MDH2616-A	0.5 - 4.9	100 - 620	Hex1/4"	900 g	MDC-26	6-1050530
MDH3201-A	0.1 - 1.17	150 - 2000	Hex1/4"	1085 g	MDC-32	6-1050531
MDH3202-A	0.2 - 2.15	150 - 2000	Hex1/4"	1095 g	MDC-32	6-1050532
MDH3204-A	0.4 - 3.9	150 - 1500	Hex1/4"	1260 g	MDC-32	6-1050533
MDH3211-A	1 - 8.8	50 - 690	Hex1/4"	1320 g	MDC-32	6-1050534
MDH3216-A	2 - 13.7	50 - 470	Hex1/4"	1315 g	MDC-32	6-1050535
MDH3236-Q	4 - 27	50 - 210	SQ3/8	1940 g	MDC-32	6-1050536
MDH3264-Q	8 - 49	50 - 115	SQ1/2	1930 g	MDC-32	6-1050537

Delivered without tool cable.

Model	Code
Cable MD 3 m	6-1050582
Cable reinforced MD 3 m	6-1050583
Cable MD 5 m	6-1050584
Cable reinforced MD 5 m	6-1050585





MDA Series

Fixtured spindle for automation 0,01 to 49 Nm



Model	Torque (Nm)	Speed range (rpm)	Drive	Weight (g)	Suitable Controller	Code
MDA2201-EC **	0.010 - 0.068	100 - 1000	Half moon		MDC-26	6-1050538
MDA2601-E	0.03 - 0.39	150 - 2000	Half moon	525 g	MDC-26	6-1050539
MDA2602-A	0.05 - 0.68	150 - 2000	Hex1/4" or dia.4	530 g	MDC-26	6-1050541
MDA2604-A	0.2 - 1.37	150 - 1500	Hex1/4" or dia.4	610 g	MDC-26	6-1050542
MDA2611-A	0.4 - 3.3	100 - 900	Hex1/4"	640 g	MDC-26	6-1050543
MDA2616-A	0.5 - 4.9	100 - 620	Hex1/4"	640 g	MDC-26	6-1050544
MDA3201-A	0.1 - 1.17	150 - 2000	Hex1/4"	770 g	MDC-32	6-1050545
MDA3202-A	0.2 - 2.15	150 - 2000	Hex1/4"	780 g	MDC-32	6-1050546
MDA3204-A	0.4 - 3.9	150 - 1500	Hex1/4"	945 g	MDC-32	6-1050547
MDA3211-A	1 - 8.8	50 - 690	Hex1/4"	1005 g	MDC-32	6-1050548
MDA3216-A	2 - 13.7	50 - 470	Hex1/4"	1000 g	MDC-32	6-1050549
MDA3236-Q	4 - 27	50 - 210	SQ3/8	1550 g	MDC-32	6-1050550
MDA3264-Q	8 - 49	50 - 115	SQ1/2	1560 g	MDC-32	6-1050551

** MDA 2201-EC are delivered with Vacuum system.
Delivered without tool cable.

Model	Code
Cable MD 3 m	6-1050582
Cable reinforced MD 3 m	6-1050583
Cable MD 5 m	6-1050584
Cable reinforced MD 5 m	6-1050585



MDC Controller Features

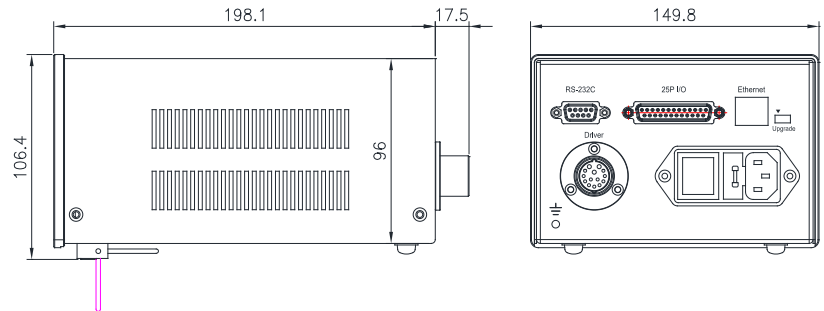

Dimensions : 150(W) 198 (D) 106 (H) Weight : 2



MDC-26 and MDC 32 Controller are also available with Memory card for data traceability. See MDC-26 M and MDC-32 M hereunder.

Item	Specifications	
	MDC-26 Code 6-1050571 MDC-26 M Code 6-1050573	MDC-32 Code 6-1050572 MDC-32 M Code 6-1050574
Input	AC120VC / AC230V, 50/60Hz	
Output	DC38V 3.5A	
Fuse	230V 10A	
Operating environment	0 ~ 40°C / 15 ~ 80% RH (without dew)	
Front panel	4.3" Color LCD with touch screen	
Communication	1 x RS232C, 1 x Ethernet	
Protocol	Modbus RTU, Modbus TCP/IP	
I/O	8 Inputs & 8 Outputs assignable I/O (25P D-Sub)	
Tightening strategies	15	
Torque calibration	- 10% ~ +10%	
Screwdriver recognition	Auto detection of connected driver when power ON of controller	
Error display	Error code display (3 groups)	
Fastening verification	Fastening data verification (NG/OK) by the preset pattern of angle.	

Optional accessories :

- RS232 Cable DB9 Male/DB9 Female 3 meters Code : 6-1050598
- USB to RS232 converter Code : 6-1050597
- Lift-up stand kit Code : 6-1050592



MDC Controllers

Main features

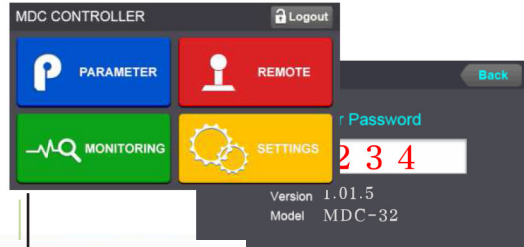
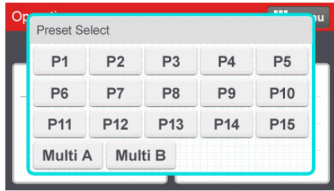

15 tightening programs
Fastening result OK/NG
Torque Monitoring

Menu
Date & Time
Torque / angle target,
Speed target/Monitoring
Count target/Monitoring
Monitoring angle/time

MDC controller

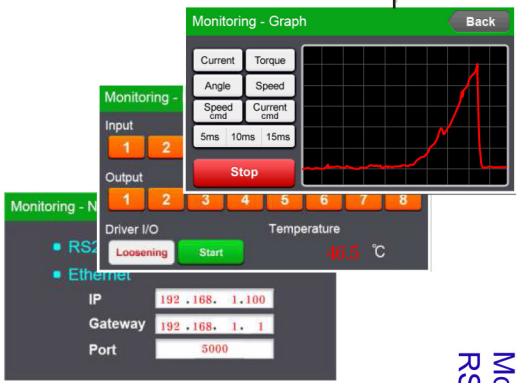

Modbus protocol
RS232 or Ethernet



ParaMon Touch Interface - option

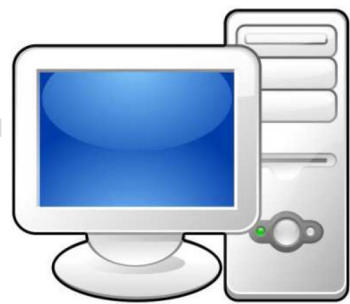

PC (Free software - ParaMon)



PLC

MDC Controllers

Self learning mode

Self-learning mode for optimized tightening parameters

Total 15 tightening programs with 15 key parameters. These strategies can be extended up to 99 with optional ParaMon Touch interface.

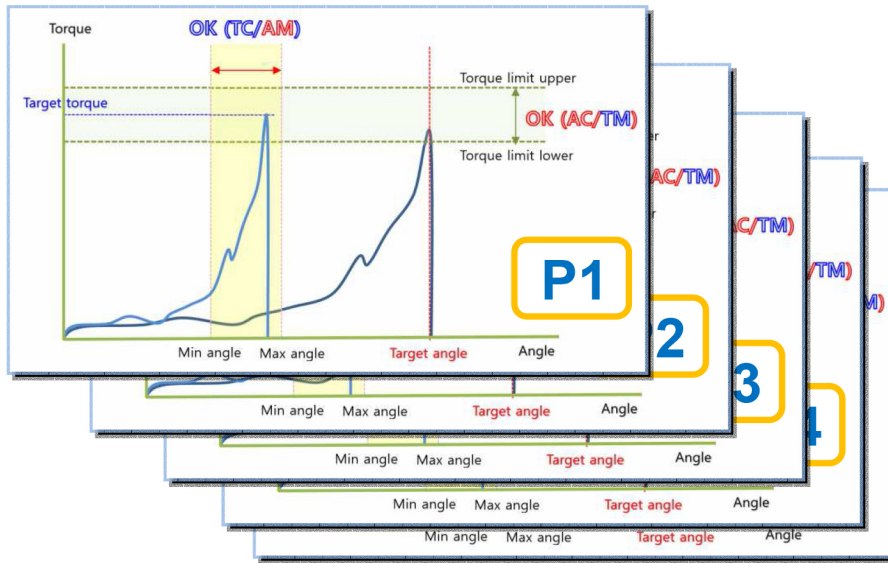

Each tightening programs features the following customized parameters

- Tightening mode
 - Torque control + angle monitoring (TC/AM)
 - Angle control + torque monitoring (AC/TM)
- Torque
 - Target torque, min/max torque, snug torque, seating torque, torque compensation
- Angle
 - Target angle, min/max angle, free speed angle
- Speed
 - Target speed, Free speed
- Time
 - Soft start time, torque rising time, torque holding time



[Self-learning mode]

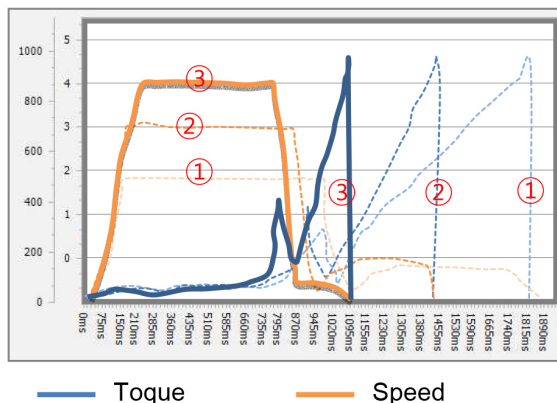

Self-learning mode determines the best parameters to provide the best torque accuracy within the highest possible speed.





MDC Controllers

Sequencing models

Sequencing Models of 10 steps with assignable tightening program, batch counting. Logical I/O management

Sample program of sequence control

- Step 1 - Input
Detect workpiece arrival on the position.
- Step 2 - Delay
Time delay 0.5 second to the next step
- Step 3 - Output
Lock the workpiece with air cylinder
- Step 4 - Tightening
Tightening total 7 with Preset #12
- Step 5 - Output
Release the workpiece from air cylinder lock



Communication – Data output

Through RS232 (Modbus RTU) or Ethernet port (Modbus TCP/IP ADU)

Modbus RTU

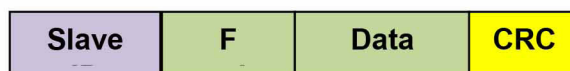

Modbus TCP/IP ADU



Free PC software

Auto data output on every event in Modbus protocol.

Fastening Setting

Address...	Parameter	Parameter value	Min value	Max value
Preset No.: 01				
A001	Type	<input checked="" type="radio"/> TC/AM <input type="radio"/> AC/TM	0	1
A002	Target torque	5	4	34
A003	Torque limit (%)	3.5	0	100
A004	Target angle (not use)	0	0	9999
A005	Min angle (degree)	360	0	9999
A006	Max angle (degree)	1080	0	9999
A007	Snug torque	0	0	34
A008	Speed (rpm)	113	100	900
A009	Free angle (degree)	0	0	9999
A010	Free speed (rpm)	0	0	900
A011	Soft start (ms)	0	0	300
A012	Seating point torque (%)	50	10	95
A013	Torque rising time (ms)	50	50	200
A014	Torque holding time (ms)	2	1	20
A015	Torque compensation (%)	100	80	120

Fastening parameter setting

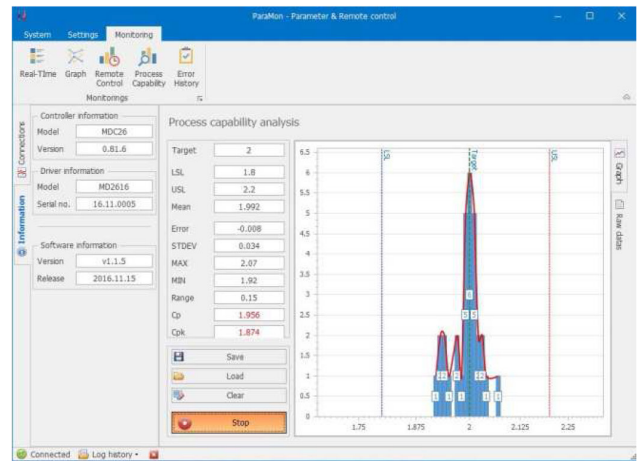

Process capability analysis

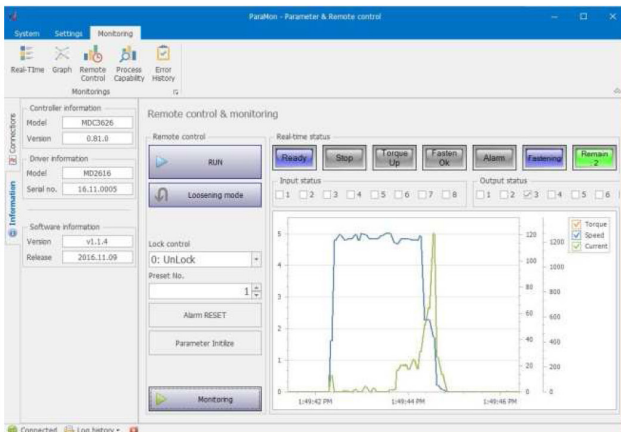

Remote control & monitoring

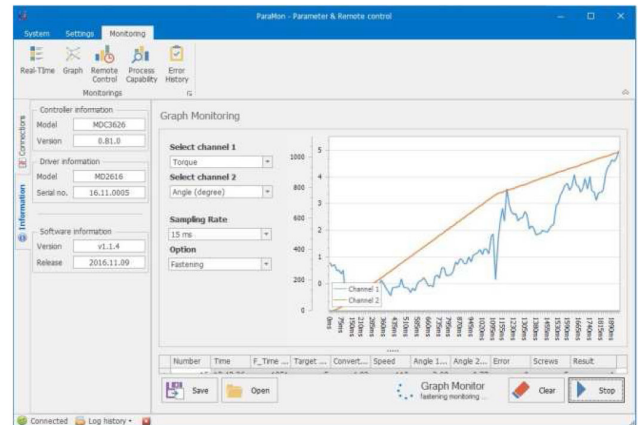

Real-time graph monitoring (2 channel)

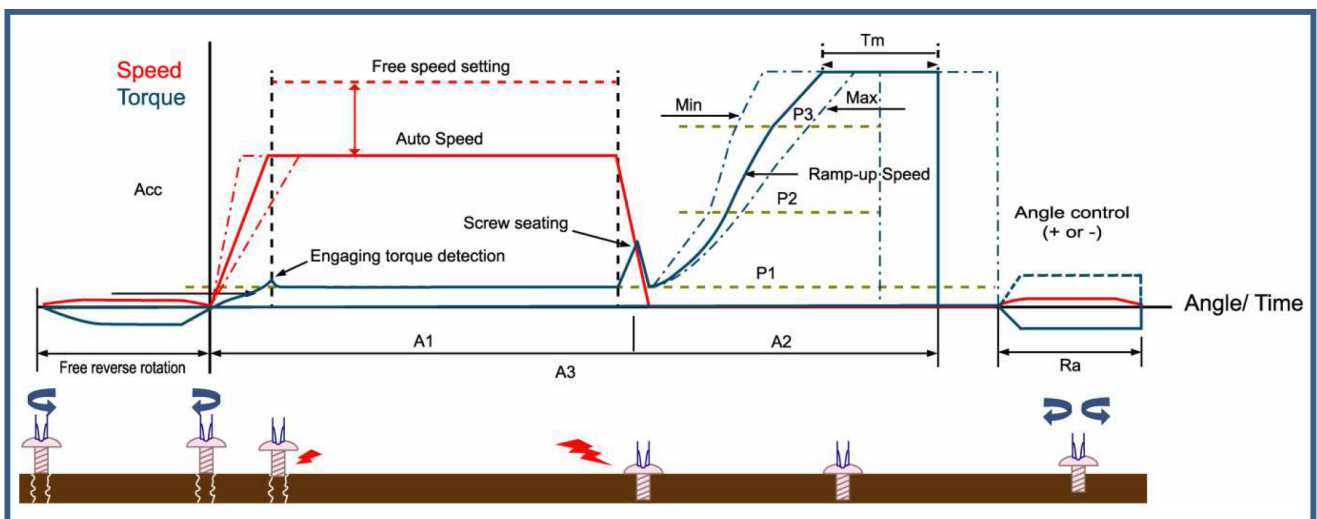



Optional accessories

■ Vacuum pick-up assy (VPA)



*Mouthpiece is not included
It should be customized according
screw features and application details.*

Item	Specification	Screwdriver	Bit length	Code
Vacuum Pick-up Assy	Hex 1/4" M20	MD26xx-A	70 mm	6-1050589
Vacuum Pick-up Assy	Hex 1/4" M23	MD32xx-A	70 mm	6-1050590
Vacuum Pick-up Assy	Half moon M20	MD26xx-E	70 mm	6-1050591

■ Bit holder assy

Extra bit holder with bearing provide better bit concentricity



Item	Specification	Screwdriver	Bit length	Code
Bit Holder Assy	Hex 1/4" M20	MD26xx-A	Ohmi V-17, 70 mmL	6-1050586
Bit Holder Assy	Hex 1/4" M23	MD32xx-A	Ohmi V-17, 70 mmL	6-1050587
Bit Holder Assy	Dia. 4 mm M20	MD26xx-E	Dia. 4 mm half moon	6-1050588

Optional accessories

■ ParaMon Touch Interface (optional) Code : 6-1050596

8' color TFT LCD with touch screen pad, ParaMon Touch provides total 99 extended Presets and Sequencing models. Programs are saved in the pad itself and change settings through the preset #1 of the controller. Automatic data saving in SD card.



- Power : DC24V 1A
- Connection to MDC by RS232
- Total 99 tightening programs
- Total 99 sequencing models
- 7 inputs to select 99 programs
- Data memory in SD card
- Include same settings of MDC
- Easy mounting on the panel

Data collection - MDC programming - Fastening process monitor

■ 44P I/O Wiring Box (optional)

For easy and convenient wiring - 12 inputs and outputs of MDC controller by sharing one single 24V power source.



I/O wiring box D-Sub 44P

Output port has the relay contact with the max 1A capacity for each port. Be sure that the 24VDC power supply should have enough capacity for total output load

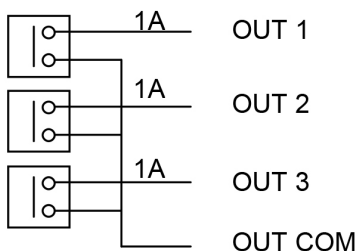

D_Sub 44P		D_Sub 44P		D_Sub 44P	
1	IN 1	16	OUT 1	31	24V+
2	IN 2	17	OUT 2	32	24V+
3	IN 3	18	OUT 3	33	24V+
4	IN 4	19	OUT 4	34	-
5	IN 5	20	OUT 5	35	Out Com
6	IN 6	21	OUT 6	36	Out Com
7	IN 7	22	OUT 7	37	Out Com
8	IN 8	23	OUT 8	38	-
9	IN 9	24	OUT 9	39	-
10	IN 10	25	OUT 10	40	-
11	IN 11	26	OUT 11	41	-
12	IN 12	27	OUT 12	42	-
13	-	28	-	43	-
14	IN Com	29	Out Com	44	-
15	IN Com	30	Out Com		

ITEM	Code
44P I/O wiring box	6-1050593
I/O cable/MDC controller	6-1050595
DC Adapter + Power cable	6-1050599 + 6-1050600

Optional accessories :

- RS232 Cable DB9 Male/DB9 Female 3 meters **Code : 6-1050598**
- USB to RS232 converter **Code : 6-1050597**



8, avenue Gutenberg - CS 50510
78317 Maurepas Cedex - France
Tél. : 01 30 66 41 20 • Fax : 01 30 66 41 79

export@doga.fr

Nous travaillons constamment à l'amélioration de nos produits. De ce fait, les dimensions et indications portées dans cette brochure peuvent parfois ne pas correspondre aux dernières exécutions. De convention expresse, nos ventes sont faites sous bénéfice de réserve de propriété (les dispositions de la loi du 12/5/80 trouvent donc toute leur application).