



InterElectronic

ELECTRIC SCREWDRIVERS

delvo
Electric Screwdrivers



INTRODUCTION



InterElectronic Hungary Ltd. offers equipments, machines and different materials (ESD) of different production technologies (SMT/THT/LED). Including high quality, special request fulfilling soldering machines, devices, tools, instruments and materials for the electronic industry and services.

SERVICES

Our each and every product has a warranty granted by the InterElectronic Hungary Ltd. For more complex appliances our company offers a well-needed training for set up and usage. We grant the repair of all of the products traded by our company during and after the warranty period. As well as we guarantee the continuous supply of accessories and instruments.

DEMONSTRATION

In case if any of our products aroused your interest the InterElectronic Hungary Ltd. would be glad to visit your company and hold a presentation of the product of your interest. As far as possible we serve you by bringing demo devices with us. In the most cases of our products we are proud possessors of references nation-wide. Major machines also could be observed at our partners' site.

PRICE LIST

Most of the prices of our products can be requested on our website and will be sent via email to you. In case of special and more complex machines the prices are given after consultation individually through a price offer. If you are interested in more information or user manuals of our products we recommend you to visit our website (www.interelectronic.com), which is updated continuously with professional information. We also recommend you to visit our office, where you can purchase any of the needed devices and spare parts of the product of your interest.

ORDER/SHIPPING

Our soon to be partners are welcomed to be helped via telephone, fax or e-mail. We use different ways of delivery, depending on the preference of our partner. We can deliver your purchased product by ourselves, by freight or courier service. The way of delivery might be negotiated previously. We offer you cash on delivery nation-wide!

Classification in this catalog

Power type	— The type of power source is indicated.
Brush motor Brushless motor	— The type of motor is indicated.
Miniature screw Precision screw Machine screw	— The type of screw* is indicated.
Screw Size	— The size range of screw is indicated.

* Miniature screw ... for 1.0 to 2.6 mm
 Precision screw ... for 1.0 to 3.5 mm
 Machine screw ... for 2.6 to 8.0 mm



About Torque Management

The fastening torque generated on the screw varies depending on the screw size, material and the type of workpiece. Always check and manage the torque generated on the screw with a torque wrench., etc. The fastening torque varies depending on the fastening conditions.









CONTENTS

List of Screwdrivers	4
C Series (Current Control Type)	8
S Series (Variable Speed Type)	11
A Series (Low Voltage Type [DC])	14
A Series (Transformerless Type [AC])	15
DLV02/12/16 Series	16
DLV7400A Series	17
DLV5700 Series	18
DLV5800 Series	19
DLV7300 Series	20
DLV7300-BME/BKE Series	21
DLV7500/8500 Series	22
DLV7000/8000 Series	24
DLV7100/7200/8100/8200 Series	25
DLV7104/8104/8204 Series	26
Screw Fastening Counters	27
DLR5640-WN	28
Screwdrivers designed for DLR5640-WN	29
DLR5040A/5340-WE	30
A Series (For Automation)	31
DLV3100/3300 Series (For Automation)	33
DLT1173A/1673A/1973A	34
NK BIT	35
Vacuum Pickups and Sleeves	37
Accessories	38

Quick Reference Symbols

	Lever Start Operates when the lever is pressed.		Push to Start Operates when the screwdriver is pressed.		Transformerless A dedicated controller is not required. Operates by commercial power supply.		Low Voltage Connect to dedicated controller. Operates at electric voltage under 42V.
	Brushless Motor Maintenance free, no brush replacement required. Realizes high durability.		Grounded Bit Prevents electrostatic breakdown when the bit contacts the workpiece.		ESD Protection Prevents electrostatic charging and saves the workpiece from electrostatic breakdown.		Low Shock Softens the shock at the end of tightening and lowers the load to the workpiece.
	Clean room adaption Adapts to assembly in class 5 clean rooms		Soft Stop Gradually reduces the rotation speed to improve the screw tightening quality.		Variable Speed Can be adjusted to a suitable tightening speed.		Soft Start Gradually increases the rotation speed to prevent damage to the screw head.













List of screwdrivers

Outer Appearance	Series	Model	Torque Range (Nm [lbf·in])	Screw Size (mm)		Mass (g [lbs])	Lever Start	Push to Start	ESD Protection	Soft Stop	Low Speed	Medium Speed	High Speed	Built-in Screw Counter	SPC Type available (for screw counter)	Controller	
				min.	max.											Model	Outer Appearance
	C Series (Current control type)	DLV04C10L	0.05 - 0.4 [0.4 - 3.5]	1.2	3.0	370 [0.82]	●				●	●	●	●	DCC0101		
		DLV10C10L	0.2 - 1.0 [1.8 - 8.9]	1.8	4.0		●				●	●	●	●			
	S Series (Variable speed type)	DLV30S06L	0.4 - 3.0 [3.5 - 26.6]	2.6	5.0	710 [1.57]	●	●	●	●				●	DEA0151N-AZ or DEA0241N-AZ		
		DLV30S06P					●	●	●	●				●			
		DLV30S12L					●	●	●	●				●			
		DLV30S12P					●	●	●	●				●			
		DLV30S20L	●	●	●	●				●	DEA0241N-AZ						
		DLV30S20P	●	●	●	●				●							
		DLV45S06L	2.0 - 4.5 [17.7 - 39.8]	4.5	6.0	860 [1.90]	●	●	●	●				●	DEA0151N-AZ or DEA0241N-AZ		
		DLV45S06P					●	●	●	●				●			
		DLV45S12L					●	●	●	●				●			
		DLV45S12P	●	●	●	●				●	DEA0241N-AZ						
DLV70S06L	3.8 - 7.0 [33.6 - 62.0]	5.0	8.0	●	●	●	●					●					
DLV70S06P	●	●	●	●				●			●						
	A Series	DLV30A06L	0.4 - 3.0 [3.5 - 26.6]	2.6	5.0	690 [1.52]	●	●	●	●					DEA0151N-AZ or DEA0241N-AZ		
		DLV30A06P					●	●	●	●				●			
		DLV30A12L					●	●	●	●				●			
		DLV30A12P					●	●	●	●				●			
		DLV30A20L	●	●	●	●				●	DEA0241N-AZ						
		DLV30A20P	●	●	●	●				●							
		DLV45A06L	2.0 - 4.5 [17.7 - 39.8]	4.5	6.0	840 [1.85]	●	●	●	●				●	DEA0151N-AZ or DEA0241N-AZ		
		DLV45A06P					●	●	●	●				●			
		DLV45A12L					●	●	●	●				●			
		DLV45A12P	●	●	●	●				●	DEA0241N-AZ						
DLV70A06L	3.8 - 7.0 [33.6 - 62.0]	5.0	8.0	●	●	●	●					●					
DLV70A06P	●	●	●	●				●			●						
	DLV02/12/16	DLV02SL-CKE	0.03 - 0.2 [0.3 - 1.8]	1.0	2.2	470 [1.04]	●				●			DLC16S			
		DLV02SL-BKE	●	●	●		●				●						
		DLV12SL-CKE	0.15 - 1.2 [1.3 - 10.6]	1.4	3.0		●				●						
		DLV12SL-BKE	●	●	●		●				●						
		DLV16SL-CKE	0.2 - 1.6 [1.8 - 14.2]	2.2	4.0		●	●	●	●						●	
DLV16SL-BKE	●	●	●	●				●			●						



Brushless Motor - AC Power Supply]

Outer Appearance	Series	Model	Torque Range (Nm [lbf·in])	Screw Size (mm)		Mass (g [lbs])	Lever Start	Push to Start	ESD Protection	Soft Stop	Low Speed	Medium Speed	High Speed	Built-in Screw Counter	SPC Type available (for screw counter)
				min.	max.										
	A Series	DLV30A06L	0.4 - 3.0 [3.5 - 26.6]	2.6	5.0	700 [1.54]	●				●			●	●
		DLV30A06P					●	●	●	●				●	
		DLV30A12L					●	●	●	●				●	
		DLV30A12P					●	●	●	●				●	
		DLV30A20L	●	●	●	●				●	●				
		DLV30A20P	●	●	●	●				●					
		DLV45A06L	2.0 - 4.5 [17.7 - 39.8]	4.5	6.0	870 [1.92]	●	●	●	●				●	●
		DLV45A06P					●	●	●	●				●	
		DLV45A12L					●	●	●	●				●	
		DLV45A12P	●	●	●	●				●	●				
DLV70A06L	3.8 - 7.0 [33.6 - 62.0]	5.0	8.0	●	●	●	●					●			
DLV70A06P	●	●	●	●				●			●				

List of screwdrivers

Outer Appearance	Series	Model	Torque Range (Nm [lb-ft])	Screw Size (mm)		Mass (g [lbs])	Lever Start	Push to Start	ESD Protection	Clean Room Type	High Speed	Low Shock	SPC Type available (for screw counter)	Controller		
				min.	max.									Model	Adjustable speed	Outer Appearance
	7400A	DLV7410A	0.02 - 0.2 [0.2 - 1.8]	1.0	2.3	230 [0.51]	●	●			●	●	DLC1110	●		
		DLV7410HA						●	●	●	●					
		DLV7420A	0.15 - 0.4 [1.3 - 3.5]	1.6	2.6		●	●			●	●				
		DLV7419A	0.02 - 0.2 [0.2 - 1.8]	1.0	2.3	275 [0.61]	●	●	●		●	●				
		DLV7419HA					●	●	●	●	●					
		DLV7429A	0.15 - 0.4 [1.3 - 3.5]	1.6	2.6	●	●	●			●	●				
	5700	DLV5720	0.02 - 0.2 [0.2 - 1.8]	1.0	2.3	230 [0.51]	●	●			●	●	DLC0350	●		
		DLV5720H						●	●	●	●					
		DLV5740	0.15 - 0.4 [1.3 - 3.5]	1.6	2.6		●	●			●	●				
		DLV5740H					●	●	●	●						
		DLV5750	0.1 - 0.55 [0.9 - 4.9]	1.0	3.0	300 [0.66]	●	●			●	●				
	5800	DLV5820	0.02 - 0.2 [0.2 - 1.8]	1.0	2.3	230 [0.51]	●	●			●	●	DLC0250E	●		
		DLV5820H						●	●							
		DLV5840	0.15 - 0.4 [1.3 - 3.5]	1.6	2.6	●	●									
	7300	DLV7313	0.03 - 0.15 [0.3 - 1.3]	Up to 2.0		350 [0.77]	●						DLC1213A	●		
		DLV7323	0.05 - 0.5 [0.4 - 4.4]	1.0	3.0		●									
		DLV7333	0.3 - 1.2 [2.7 - 10.6]	2.0	3.5	●										
		DLV7325	0.05 - 0.5 [0.4 - 4.4]	1.0	3.0	400 [0.88]	●		●							
		DLV7335	0.3 - 1.2 [2.7 - 10.6]	2.0	3.5		●		●							
	7300-BME/ BKE	DLV7321	0.05 - 0.5 [0.4 - 4.4]	1.0	3.0	350 [0.77]	●	●	●			●	DLC1213A	●		
		DLV7331	0.3 - 1.2 [2.7 - 10.6]		3.5		●	●	●		●					
		DLV7319	0.2 - 0.4 [1.8 - 3.5]	2.0	3.0	●	●	●								
		DLV7329	0.25 - 0.55 [2.2 - 4.9]			●	●	●								
		DLV7339	0.45 - 0.95 [4.0 - 8.4]	3.0	3.5	●	●	●								
		DLV7349	0.55 - 1.2 [4.9 - 10.6]			●	●	●								
	7500	DLV7530-MKE	0.5 - 1.7 [4.4 - 15.1]	2.6	4.0	650 [1.43]	●						DLC4511	●		
		DLV7530-BKE						●	●							
		DLV7540-MKE	1.2 - 2.7 [10.6 - 23.9]	3.5	5.0	●		●								
		DLV7540-BKE					●	●								
		DLV7550-MKE	2.0 - 4.5 [17.7 - 39.8]	4.5	6.0	750 [1.65]	●		●							
		DLV7550-BKE					●	●								
	8500	DLV8530-MKE	0.5 - 1.7 [4.4 - 15.1]	2.6	4.0	650 [1.43]	●	●	●				DLC4511	●		
		DLV8530-BKE						●	●	●						
		DLV8540-MKE	1.2 - 2.7 [10.6 - 23.9]	3.5	5.0	●		●								
		DLV8540-BKE					●	●	●							
		DLV8550-MKE	2.0 - 4.5 [17.7 - 39.8]	4.5	6.0	750 [1.65]	●		●							
		DLV8550-BKE					●	●								

List of screwdrivers

Outer Appearance	Series	Model	Torque Range (Nm [lbf·in])	Screw Size (mm)		Mass (g [lbs])	Lever Start	Push to Start	ESD Protection	High Speed	SPC Type available (for screw counter)		
				min.	max.								
	7000	DLV7020	0.05 - 0.55 [0.4 - 4.9]	1.0	3.0	400 [0.88]	●				●		
		DLV7030	0.3 - 1.1 [2.7 - 9.7]	2.0	3.5		●				●	●	
		DLV7031	0.3 - 1.0 [2.7 - 8.9]		3.0		●		●	●	●		
	8000	DLV8020	0.1 - 0.55 [0.9 - 4.9]	1.0	3.0	410 [0.90]		●			●	●	
		DLV8030	0.3 - 1.1 [2.7 - 9.7]	2.0			3.5	●				●	●
		DLV8031	0.3 - 1.0 [2.7 - 0.9]	3.0			3.0	●		●	●	●	
	7100/ 7200	DLV7120	0.35 - 0.70 [3.1 - 6.2]	2.6	4.0	700 [1.54]	●				●		
		DLV7130	0.5 - 1.7 [4.4 - 15.1]				●				●	●	
		DLV7140	1.2 - 3.0 [10.6 - 26.6]	3.5	5.0		●				●		
		DLV7221	0.35 - 0.7 [3.1 - 6.2]	2.6	3.0		●			●			
		DLV7231	0.5 - 1.7 [4.4 - 15.1]		4.0		●		●	●	●		
		DLV7241	1.2 - 3.0 [10.6 - 26.6]	3.5	5.0		●				●		
		DLV7251	2.0 - 4.5 [17.7 - 39.8]	4.5	6.0		890 [1.96]	●				●	
	8100/ 8200	DLV8120	0.35 - 0.70 [3.1 - 6.2]	2.6	3.0	690 [1.52]		●			●		
		DLV8130	0.5 - 1.7 [4.4 - 15.1]		4.0		●			●	●		
		DLV8140	1.2 - 3.0 [10.6 - 26.6]	3.5	5.0		●				●		
		DLV8150	2.0 - 4.5 [17.7 - 39.8]	4.5	6.0	890 [1.96]	●				●		
		DLV8221	0.35 - 0.7 [3.1 - 6.2]	2.6	3.0	690 [1.52]		●		●			
		DLV8231	0.5 - 1.7 [4.4 - 15.1]		4.0		●		●	●	●		
		DLV8241	1.2 - 3.0 [10.6 - 26.6]	3.5	5.0		●				●		
DLV8251	2.0 - 4.5 [17.7 - 39.8]	4.5	6.0	890 [1.96]	●				●				
	7104/ 8104/ 8204	DLV7124	0.25 - 0.75 [2.2 - 6.6]	2.6	3.0	720 [1.59]	●		●				
		DLV7134	0.5 - 1.7 [4.4 - 15.1]		4.0		●		●				
		DLV7144	1.2 - 3.0 [10.6 - 26.6]	3.5	5.0		●		●				
		DLV8124	0.25 - 0.75 [2.2 - 6.6]	2.6	3.0	710 [1.57]		●		●			
		DLV8134	0.5 - 1.7 [4.4 - 15.1]		4.0		●		●	●			
		DLV8144	1.2 - 3.0 [10.6 - 26.6]	3.5	5.0		●		●				
		DLV8154	2.0 - 4.5 [17.7 - 39.8]	4.5	6.0	910 [2.01]	●		●		●		
		DLV8224	0.35 - 0.7 [3.1 - 6.2]	2.6	3.0	710 [1.57]		●		●	●		
		DLV8234	0.5 - 1.7 [4.4 - 15.1]		4.0		●		●	●	●		
		DLV8244	1.2 - 3.0 [10.6 - 26.6]	3.5	5.0		●		●				



Outer Appearance	Series	Model	Torque Range (Nm [lbf·in])	Screw Size (mm)		Mass (g [lbs])	Low Speed	Medium Speed	High Speed	Coupling			
				min.	max.					Standard	Flange	M41 Screw	
													Type of couplings
	A Series (for automation)	DLV30A06A-N	0.4 - 3.0 [3.5 - 26.6]	2.6	5.0	700 [1.54]	●			●			
		DLV30A06A-F				760 [1.68]	●			●			
		DLV30A06A-M				740 [1.63]	●			●			
		DLV30A12A-N				700 [1.54]		●		●			
		DLV30A12A-F				760 [1.68]		●		●			
		DLV30A12A-M				740 [1.63]		●		●			
		DLV30A20A-N				700 [1.54]			●	●			
		DLV30A20A-F				760 [1.68]			●	●			
		DLV30A20A-M				740 [1.63]			●	●			
		DLV45A06A-N	2.0 - 4.5 [17.7 - 39.8]	4.5	6.0	780 [1.72]	●			●			
		DLV45A06A-F				840 [1.85]	●			●			
		DLV45A06A-M				820 [1.81]	●			●			
		DLV45A12A-N				780 [1.72]		●		●			
		DLV45A12A-F				840 [1.85]		●		●			
		DLV45A12A-M				820 [1.81]		●		●			
		DLV70A06A-N	3.8 - 7.0 [33.6 - 62.0]	5.0	8.0	780 [1.72]	●			●			
		DLV70A06A-F				840 [1.85]	●			●			
		DLV70A06A-M				820 [1.81]	●			●			



Standard coupling



Flange coupling



M41 screw coupling

Brush Motor]

Outer Appearance	Series	Model	Torque Range (Nm [lbf·in])	Screw Size (mm)		Mass (g [lbs])	Controller	
				min.	max.		Model	
								Type of couplings
	3100 (for automation)	DLV3121	0.25 - 0.7 [2.2 - 6.2]	2.3	2.6	900 [1.98]	Transformerless (controller not required)	
		DLV3131	0.5 - 1.5 [4.4 - 13.3]	2.6	3.5			
		DLV3141	1.2 - 3.0 [10.6 - 26.6]	3.5	5.0			
		DLV3151	2.0 - 4.5 [17.7 - 39.8]	4.5	6.0			
	3300 (for automation)	DLV3321	0.05 - 0.5 [0.4 - 4.4]	1.0	3.0	400 [0.88]	DLC3310	
		DLV3331	0.3 - 1.2 [2.7 - 10.6]	2.0	3.5			

Low Voltage (DC)		
Brush motor	Brushless motor	
Miniature screw	Precision screw	Machine screw
1.2 - 4.0 mm		



Delvo Brushless Type

C Series (Current control Type) Model DLV04C/10C



Features

- Easy fastening setting by controller
- Current Controlled Torque System suitable for screw fastening work
- Low-voltage brushless motor
- ESD (electrostatic discharge) protection structure
- For both hand-held / automatic machines
- Controller has built in counting function. Prevents human errors

Four screwdrivers can be consolidated into one

- Controller can be set to any torque and speed within range.

* The range varies depending on SOFT fastening or HARD fastening.

0.25 Nm	450 min ⁻¹		1st unit
0.15 Nm	600 min ⁻¹		2nd unit
0.35 Nm	1000 min ⁻¹		3rd unit
0.30 Nm	450 min ⁻¹		4th unit



Torque: 0.05 - 0.4 Nm (DLV04C)
[0.44 - 3.54 lbf-in]
0.2 - 1.0 Nm (DLV10C)
[1.77 - 8.85 lbf-in]

Speed: 100 - 1000 min⁻¹

Torque range 0.05 - 1.0 Nm

* When the same bit is used.

All in one!

- Easily adapts for use in automatic machines

The sequencing of the screwdrivers can be controlled by a PLC.

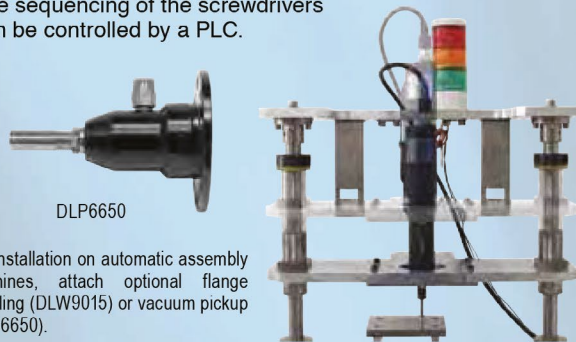

DLP6650

For installation on automatic assembly machines, attach optional flange coupling (DLW9015) or vacuum pickup (DLP6650).

- Built-in Screw Fastening Counter Function

Controller has built in counting function. Prevents human errors.

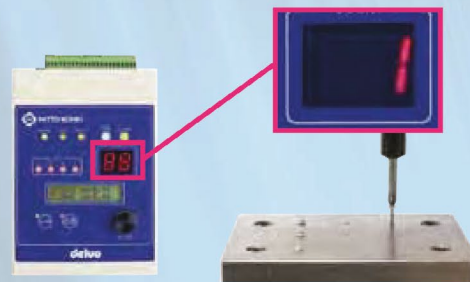

Specifications

Model	Bit	CE/UL	DLV04C10L-AY		DLV10C10L-AY	
			K	M	K	M
Power Source		PSE	DCC0101X-AZP or DCC0101X-AZN			
Torque Adjustment		Stepless				
Torque	SOFT fastening setting (1000 min ⁻¹ setting)	0.05 - 0.4 [0.4 - 3.5]		0.2 - 1.0 [1.8 - 8.9]		
	SOFT fastening setting (600 min ⁻¹ setting)	0.05 - 0.35 [0.4 - 3.1]		0.2 - 0.45 [1.8 - 4.0]		
	HARD fastening setting	0.05 - 0.4 [0.4 - 3.5]		0.2 - 1.0 [1.8 - 8.9]		
Free Speed (min ⁻¹)	SOFT fastening setting	600 - 1000				
	HARD fastening setting	100 - 1000				
Screw Size (mm)	Machine screw	1.2 - 3.0		1.8 - 4.0		
	Tapping screw	1.1 - 2.5		1.6 - 3.5		
Bit Type	NK35 (OD6.35 mm [1/4"] Hex. Shank)					
Input Voltage	24 V DC					
Mass	370 g [0.82 lbs]					
Rated Operation	ON: 0.5 seconds / OFF: 3.5 seconds					

Please contact us for 4 mm bit type ("M" Bit) of CE/UL models.





Model	DCC0101X-AZ	P*
Input Voltage	AC100 - 240 V AC, 50/60Hz	
Operation Channel	Torque and speed setting in 4-channel memory	
Function	Can switch to any operation channel	
Count Function	Tracks screws fastened Workpiece detector can be incorporated	
External Start up	Start up control can be enabled by external input signal	
Control Function		
Input Signal Method	Photocoupler input (24 V DC drive (5 mA/1 input), respond to PNP output)	
Output Signal	Photocoupler output	
Method	(30 V DC or less, 30 mA/1 output or less, PNP output method)	
Service Power Source	24 V DC (Maximum capacity 200 mA)	
Power consumption	When on standby: 20 W During electric screwdriver rotation (rated): 30 W	
Mass	1100 g [2.4 lbs]	
Power cord (Optional)*	DLW9220 / DLW9240 / DLW9250	

*DCC0101X-AZN with NPN output also available

*The power cord is sold separately. Ask us for the required power cord when ordering. (see page 9 "Optional Accessories")

Delvo Brushless Type

Comparison of Adjustment Method with Conventional Model

Torque adjustment		Torque is adjusted by turning the adjustment ring at the end of the screwdriver.		Can be set with the external controller. No need to adjust the screwdriver body.
Conventional		➔	C Series	
Speed setting		The speed of transformerless type screwdrivers is fixed for each series.		Can be set with the external controller. Adjustable between 100 to 1000 min ⁻¹ .

SOFT / HARD Fastening Settings

Two types of fastening mode available subject to the workpiece.

Coordinate the actual workpieces, screws and operating conditions and determine the fastening mode.

SOFT fastening setting

Suitable for workpieces with high fastening load such as tapping screws or fastening soft objects such as rubber.

HARD fastening setting

Suitable for workpieces with small fastening load such as threaded holes or rigid bodies such as metal.

Output Torque and Rotation Speed

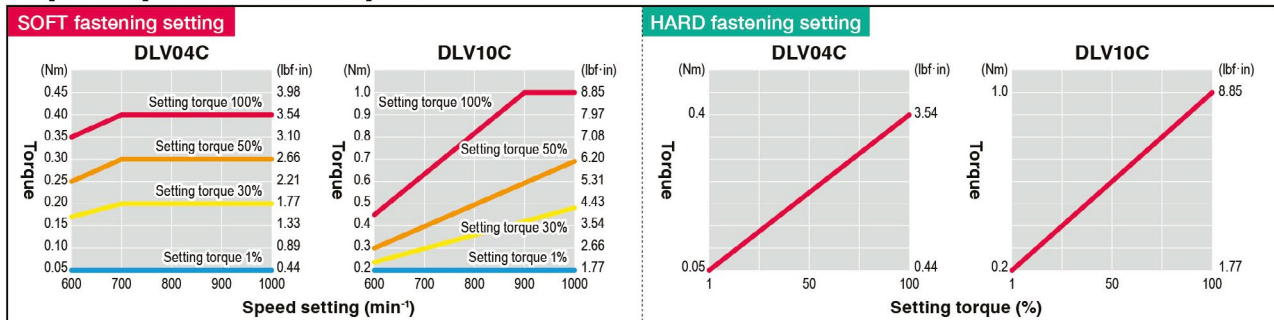

*The graph is for guidance only. The output torque range is not guaranteed.











External Signals

You can input or output external signals via a signal terminal block.

Terminal No.	Function	Details	I/O
1 (+)	+24 V DC	Built-in service power source (Capacity: Maximum 200 mA)	Service power source
2 (-)	0 V DC	• Use in power source for input/output signal common wire, or for the workpiece detection sensor, etc.	
3	Channel A	In the 2-bit input signal, specify the operation channel (CH1 to CH4) • Valid only when "operation channel switching method" (No.1 CH-CHG) is set to "INPUT"	Input
4	Channel B		
5	Forward rotation startup	Startup with external input signal	
6	Reverse rotation startup		
7	WORK	Input the workpiece signal (workpiece detection sensor output) • With "count function" (No.11 COUNT-FNC) and "workpiece signal" (No.12 WORK-SNSR) set to ON, the workpiece signal input is valid	
8	WORK RESET	Reset operation (same as controller [WORK RESET] button)	
9	Keylock	Lock the controller button operation • Disable the controller button operation, and prevent setting changes by the operator	
10	Input signal negative common wire	Connect 0 V DC* • Service power source (terminal No.2) or external 0 V DC power source can be connected	
11	Forward rotation signal	Set output signal during forward rotation to ON	Output
12	Reverse rotation signal	Set output signal during reverse rotation to ON	
13	Count-up (C-UP)	Performance of normal screw tightening (torque-up) sets output signal to 0.3 seconds ON	
14	Screw fastening NG (F-NG)	If screw fastening NG, sets output signal to 0.3 seconds ON	
15	Operation channel 1 (CH1)	Set the channel output signal to ON during operation or settings	
16	Operation channel 2 (CH2)		
17	Operation channel 3 (CH3)		
18	Operation channel 4 (CH4)		
19	Operation OK	If the set count screw tightening is judged to be completed and operation OK, the output signal is set to ON	
20	Operation NG	When the WORK input signal is OFF during an operation, and the operation is judged to be NG, the output signal is ON	
21	Space	Connection impossible	
22	Output signal positive common wire	Connect +24 V DC* • Service power source (terminal No.1) or external +24 V DC can be connected	

Delvo Brushless Type

Optional Accessories

Grounded 3-Prong Power Cord DLW9220 DLW9240 DLW9250  North America Europe UK			Screw vacuum pump DLP2530 (100 V), DLP2570 (230 V) Connect the tube to the vacuum pickup port. The vacuum will pick up the screw. 	
Torque checker DLT1173A 	Screw joint (with white rubber) DLW4540 	Screw joint (with black rubber) DLW4550 	Screw joint (with metal washer) DLW4560 	
*For DLV04C10L-AY SOFT fastening torque measurement		*For DLV10C10L-AY SOFT fastening torque measurement		*For HARD fastening torque measurement of both DLV04/10C10L-AY
For "K" Bit		For "M" Bit		
Vacuum pickup DLP6640 	Vacuum pickup (for automatic machine) DLP6650 	Vacuum pickup DLP6600 	Vacuum pickup (for automatic machine) DLP6610 	Flanged coupling (for automatic machine) DLW9015 

* Please see page 39 for details.

External Dimensions

•DLV04C/10C

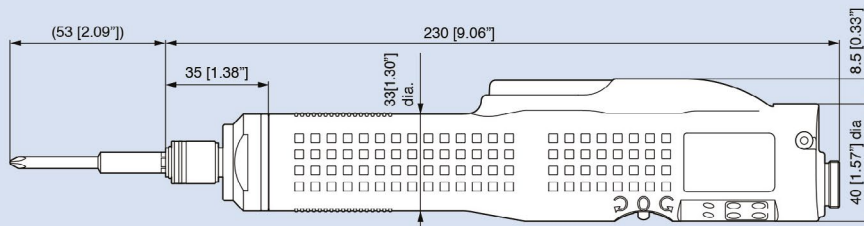

•DCC0101X

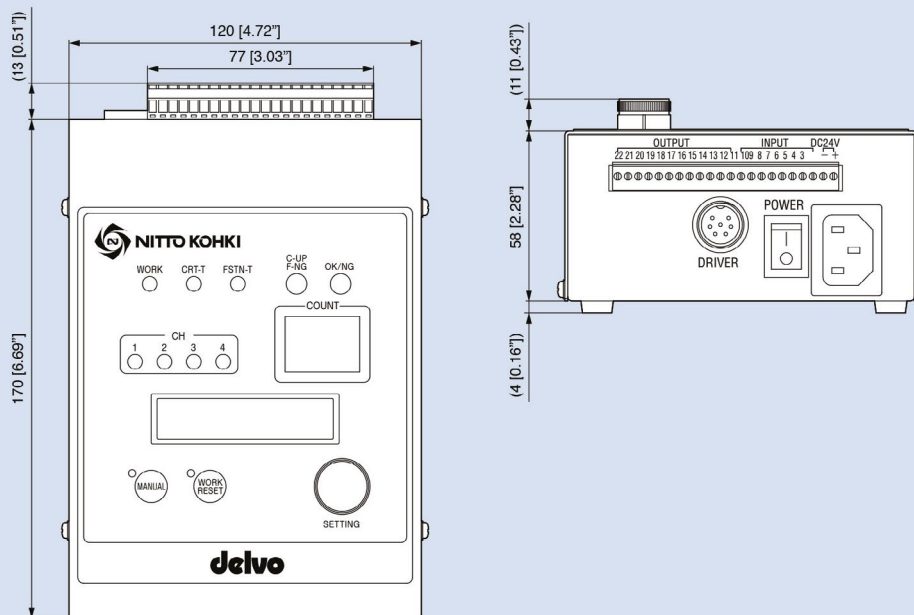

unit: mm [inch]

Low Voltage (DC)		
Brush motor	Brushless motor	
Miniature screw	Precision screw	Machine screw
2.6 - 8.0 mm		



Delvo Brushless Type

S Series (Variable speed Type) Model DLV30S/45S/70S



Features

- Built-in brushless motor
- Automatic speed control function
- Built-in screw counting function
- Setting with the Remote Controller
- ESD (electrostatic discharge) protection structure

This screwdriver can deal with various fastening conditions.

Torque range **0.4 - 7.0 Nm**
[3.5 - 62.0 lbf-in]

Built-in Automatic Speed Control Function

Low speed starting reduces the problems at start.

<Step 1>

High speed feeding at middle improves efficiency and quality of screw fastening work.

<Step 2>

Low speed fastening at finish reduces the problems at finish.

<Step 3>

Built-in the Functions of Screw Fastening Counter

- screw count setting
- fastening time setting, and fastening time measurement



Main LED mounted on the screwdriver

LEDs and Setting Buttons on the Screwdriver



Part Names of the Remote Controller



Specifications

		Low Speed	Standard	High Speed	Low Speed	Standard	Low Speed
Model	Bit	DLV30S06L-AY:K	DLV30S12L-AY:K	DLV30S20L-AY:K	DLV45S06L-AY:K	DLV45S12L-AY:K	DLV70S06L-AY:K
	Lever Start	DLV30S06P-AY:K	DLV30S12P-AY:K	DLV30S20P-AY:K	DLV45S06P-AY:K	DLV45S12P-AY:K	DLV70S06P-AY:K
Power Source		DEA0151N-AZ or DEA0241N-AZ		DEA0241N-AZ	DEA0151N-AZ or DEA0241N-AZ		DEA0241N-AZ
Torque Adjustment		Stepless					
Torque (Nm [lbf-in])	Low Torque Spring*1	0.4 - 1.6 [3.5 - 14.2]			2.0 - 4.5 [17.7 - 39.8]		3.8 - 7.0
	High Torque Spring*2	1.2 - 3.0 [10.6 - 26.6]					[33.6 - 62.0]
Free Speed (min ⁻¹)		For the details, see separate setting range of speed and torque.					
Speed Level		Lv1 - Lv9 (Lv1: Min. Speed Lv9: Max. Speed decreases in a step-by-step manner)					
Power Consumption (W)		44					
Screw Size (mm)	Machine Screw	2.6 - 5.0			4.5 - 6.0		5.0 - 8.0
	Tapping Screw	2.5 - 4.0			4.0 - 5.0		4.5 - 6.0
Mass (g [lbs])		710 [1.57]					
Standard Accessories*3		• Bit NK35 × 2 × 7 × 75 • Low Torque Spring • Suspension Bail		• Connection Cord (DLW9073)		• Bit NK35 × 2 × 7 × 75 • Connection Cord (DLW9073) • Suspension Bail • Pistol Grip (DLW2300ESD)	

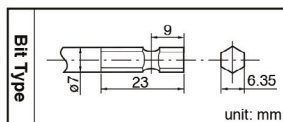

Please contact us for 5 mm bit type

*1: Standard Accessory

*2: Built-in

*3: The power cord is sold separately. Ask us for the required power cord when ordering.

Setting Range of Speed and Torque (for reference only)

Speed Level	Speed (min ⁻¹)	DLV30S06			DLV45S06			DLV70S06			Speed Level	Speed (min ⁻¹)	DLV30S12			DLV45S12			Speed Level	Speed (min ⁻¹)	DLV30S20		
		Torque (Nm [lbf-in])			Torque (Nm [lbf-in])			Torque (Nm [lbf-in])					Torque (Nm [lbf-in])			Torque (Nm [lbf-in])							
Lv1	160	0.4 - 1.3	[3.5 - 11.5]	-	-	-	-	-	-	-	Lv1	300	0.4 - 0.6	[3.5 - 5.3]	-	-	-	Lv1	500	0.4	[3.5]		
Lv2	220	0.4 - 2.0	[3.5 - 17.7]	2.0 - 2.4	[17.7 - 21.2]	-	-	-	-	-	Lv2	420	0.4 - 1.2	[3.5 - 10.6]	-	-	-	Lv2	690	0.4 - 0.8	[3.5 - 7.0]		
Lv3	280	0.4 - 2.7	[3.5 - 23.9]	2.0 - 3.5	[17.7 - 30.9]	3.8	[33.6]	-	-	-	Lv3	530	0.4 - 1.8	[3.5 - 15.9]	2.0	[17.7]	-	Lv3	880	0.4 - 1.2	[3.5 - 10.6]		
Lv4	340	0.4 - 3.0	[3.5 - 26.6]	2.0 - 4.5	[17.7 - 39.8]	3.8 - 4.6	[33.6 - 40.7]	-	-	-	Lv4	640	0.4 - 2.4	[3.5 - 21.2]	2.0 - 2.6	[17.7 - 23.0]	-	Lv4	1,060	0.4 - 1.6	[3.5 - 14.1]		
Lv5	410	0.4 - 3.0	[3.5 - 26.6]	2.0 - 4.5	[17.7 - 39.8]	3.8 - 5.4	[33.6 - 47.8]	-	-	-	Lv5	750	0.4 - 3.0	[3.5 - 26.6]	2.0 - 3.2	[17.7 - 28.3]	-	Lv5	1,250	0.4 - 2.0	[3.5 - 17.7]		
Lv6	470	0.4 - 3.0	[3.5 - 26.6]	2.0 - 4.5	[17.7 - 39.8]	3.8 - 6.2	[33.6 - 54.9]	-	-	-	Lv6	860	0.4 - 3.0	[3.5 - 26.6]	2.0 - 3.8	[17.7 - 33.6]	-	Lv6	1,440	0.4 - 2.4	[3.5 - 21.2]		
Lv7	530	0.4 - 3.0	[3.5 - 26.6]	2.0 - 4.5	[17.7 - 39.8]	3.8 - 7.0	[33.6 - 62.0]	-	-	-	Lv7	980	0.4 - 3.0	[3.5 - 26.6]	2.0 - 4.4	[17.7 - 38.9]	-	Lv7	1,630	0.4 - 2.8	[3.5 - 24.7]		
Lv8	590	0.4 - 3.0	[3.5 - 26.6]	2.0 - 4.5	[17.7 - 39.8]	3.8 - 7.0	[33.6 - 62.0]	-	-	-	Lv8	1,090	0.4 - 3.0	[3.5 - 26.6]	2.0 - 4.5	[17.7 - 39.8]	-	Lv8	1,810	0.4 - 3.0	[3.5 - 26.6]		
Lv9	650	0.4 - 3.0	[3.5 - 26.6]	2.0 - 4.5	[17.7 - 39.8]	3.8 - 7.0	[33.6 - 62.0]	-	-	-	Lv9	1,200	0.4 - 3.0	[3.5 - 26.6]	2.0 - 4.5	[17.7 - 39.8]	-	Lv9	2,000	0.4 - 3.0	[3.5 - 26.6]		

*Speed and torque are for reference only. The actual values depend on the materials to be fastened and size of screws. The values are not guaranteed.

Setting Range for Standard Models

The low speed level is effective in hard-to-fasten applications such as tapped holes in sheet metal, stainless steel, and plastic. The high speed level is effective in shortening the cycle time in an assembly line.

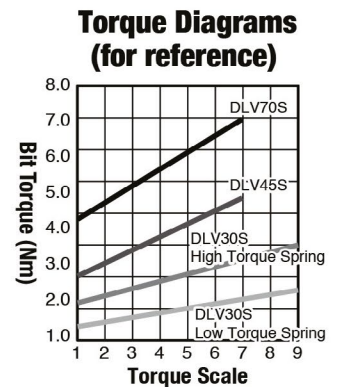
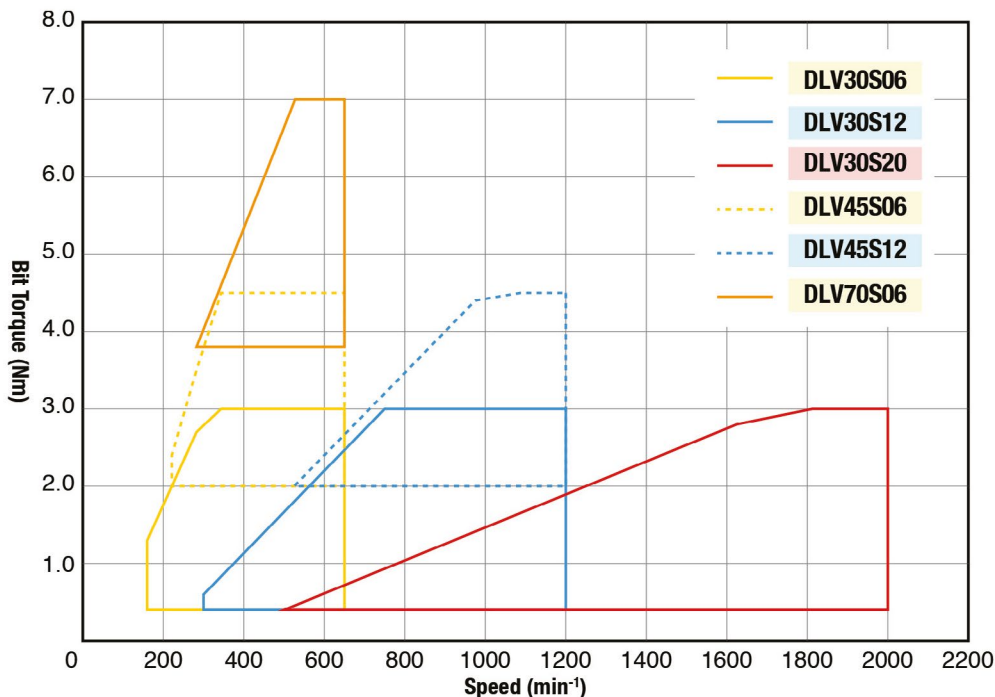

*Graphs are for reference only. The actual values depend on usage conditions.

Equipped with the External Signal Connector

The screwdriver can accept an external signal or output a signal externally through the external signal connector.

Pin No.	Lead wire color	Signal	Input / output
1	Red	+24 V DC power (supplied from outside)	
2	White	Workpiece Signal	Input
3	Green	Reset signal	Input
4	Yellow	LINK-IN	Input
		Forced stop signal	
5	Brown	OK Signal	Output
6	Blue	NG Signal	Output
7	Gray	LINK-OUT	Output
		Channel switching signal	
8	Orange	Torque-up (count) signal	Output
9	Peach	Channel A	Input
10	Purple	Channel B	Input
11	Yellow Green	Channel C	Input
12	Black	0 V DC	

Lead wire colors are the ones used in the optional signal cable ass'y DLW9090.

*Either Pin No. 4 or 7 must be selected, but not both.

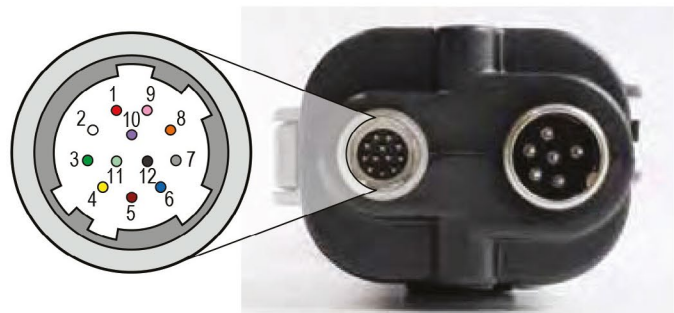

Optional Accessories

Power Supply DEA0151N-AZ DEA0241N-AZ		Grounded 3-Prong Power Cord DLW9220 DLW9240 DLW9250			Remote Controller RC1000
					
		North America	Europe	UK	
• Power cord is not included					
Signal Cable Ass'y DLW9090	Connection Cord DLW9073	Relay Cord (To connect DLW9073 and DLW9073) DLW9074			
					
*Standard accessory of screwdrivers					

External Dimensions

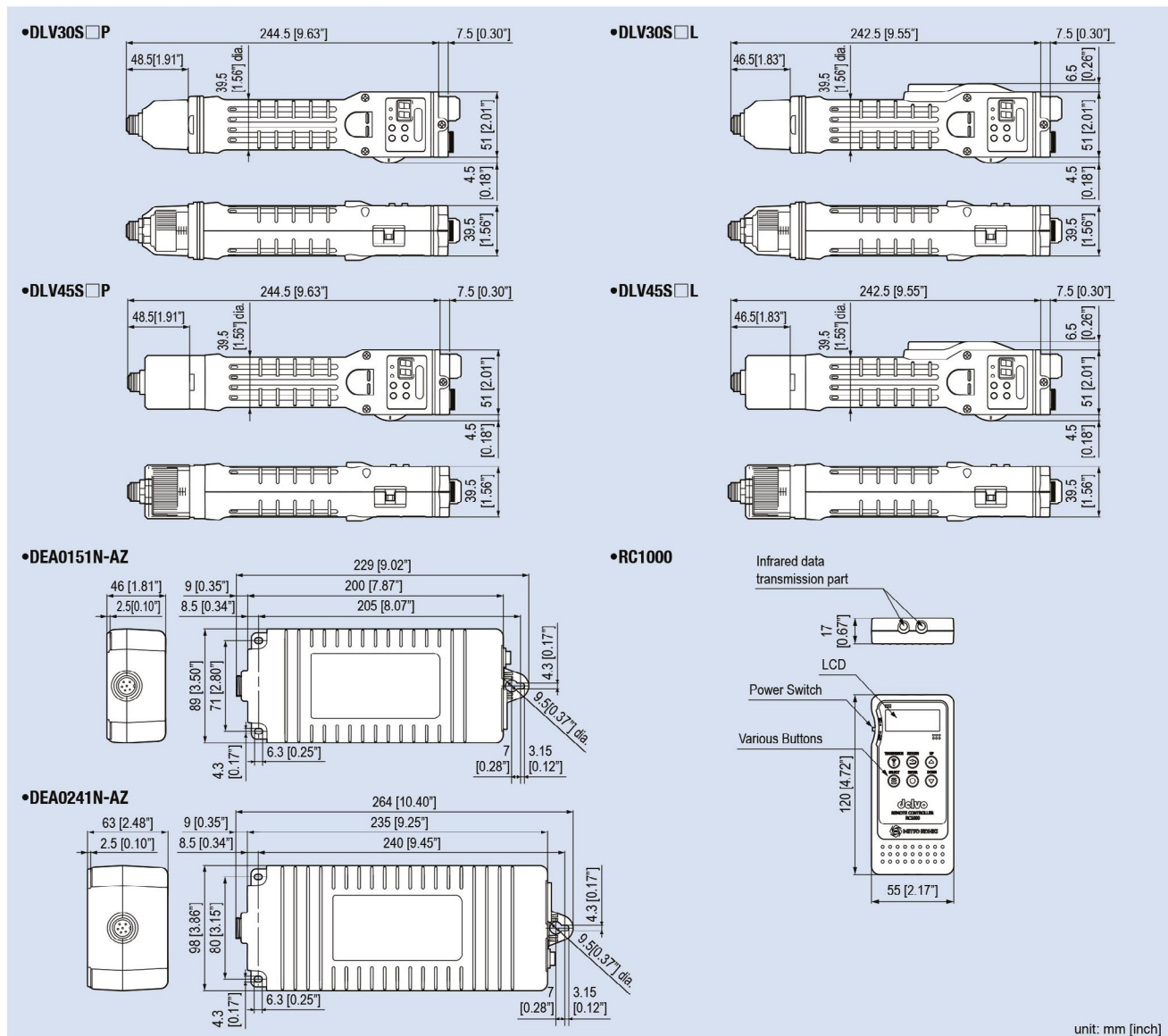

Low Voltage (DC)	
Brush motor	Brushless motor
Miniature screw	Machine screw
2.6 - 8.0 mm	

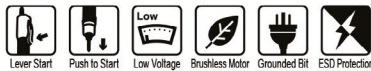

Delvo Brushless Type

A Series (Low Voltage Type) Model DLV30A/45A/70A



Features

Eco-friendly electric screwdrivers with built-in brushless motors in a low voltage (DC) profile

- Torque range from 0.4 to 7.0 Nm
- Speed range from 650 to 2000 min⁻¹
- Both the Lever Start and Push to Start type models are available
- Equipped with a torque adjustment ring cover
- Design conforms to the RoHS Directive and thus appeals to the environmentally conscious user
- Easily detachable Pistol Grip DLW2300 (TD00335) comes with the unit as a standard accessory (DLV45A/70A)
- ESD (electrostatic discharge) protection structure

Specifications

		Low Speed	Standard	High Speed	Low Speed	Standard	Low Speed	
Electric Screwdriver	Model	DLV30A06L-AY : K	DLV30A12L-AY : K	DLV30A20L-AY : K	DLV45A06L-AY : K	DLV45A12L-AY : K	DLV70A06L-AY : K	
	Bit	Lever Start	DLV30A06P-AY : K	DLV30A12P-AY : K	DLV30A20P-AY : K	DLV45A06P-AY : K	DLV45A12P-AY : K	
	Power Source	DEA0151N-AZ or DEA0241N-AZ			DEA0241N-AZ		DEA0241N-AZ	
	Torque Adjustment	Stepless						
	Torque (Nm [lbf-in])	Low Torque Spring*1		0.4 - 1.6 [3.5 - 14.2]		2.0 - 4.5 [17.7 - 39.8]		3.8 - 7.0 [33.6 - 62.0]
		High Torque Spring*2		1.2 - 3.0 [10.6 - 26.6]				
	Free Speed (min ⁻¹)	650		1200		2000		650
	Power Consumption (W)	44						
	Screw Size (mm)	Machine Screw		2.6 - 5.0		4.5 - 6.0		5.0 - 8.0
		Tapping Screw		2.5 - 4.0		4.0 - 5.0		4.5 - 6.0
Mass (g [lbs])			690 [1.52]				840 [1.85] (with Pistol Grip)	
Standard Accessories	• Bit NK35 × 2 × 7 × 75 • Suspension Bail		• Low Torque Spring • Connection Cord (DLW9073)		• Bit NK35 × 2 × 7 × 75 • Suspension Bail		• Connection Cord (DLW9073) • Pistol Grip (DLW2300ESD)	

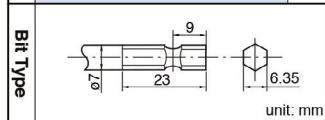

Please contact us for 5 mm bit type.

*1: Standard Accessory
*2: Built-in.

Torque Diagrams (for reference)

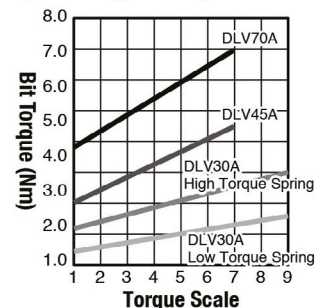

Power Supply	Model	DEA0151N-AZ	DEA0241N-AZ
Input		100 - 240 V AC, 50/60 Hz, 60 W	
Output		40 V DC	
Maximum Rated Power (W)		150	240
Mass (kg)		0.56	0.9

*The power cord is sold separately. Ask us for the required power cord when ordering.

External Dimensions

•DLV30A□P

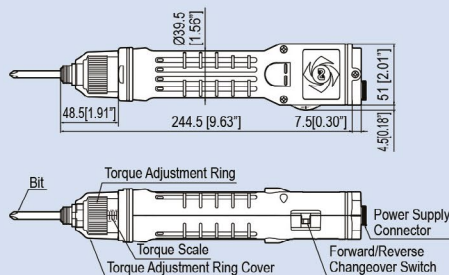

•DLV30A□L

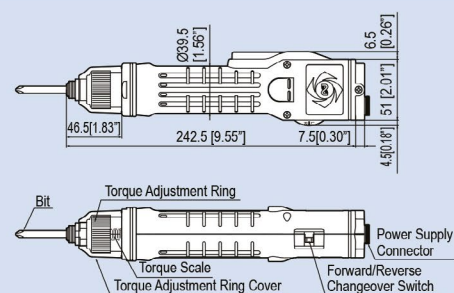

•DLV45A□P/DLV70A□P

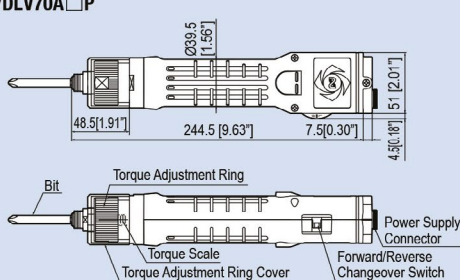

•DLV45A□L/DLV70A□L

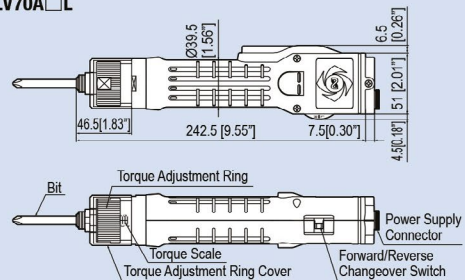

unit: mm [inch]

Transformerless (AC)		
Brush motor	Brushless motor	
Miniature screw	Precision screw	Machine screw
2.6 - 8.0 mm		



Delvo Brushless Type

A Series (Transformerless Type) Model DLV30A/45A/70A

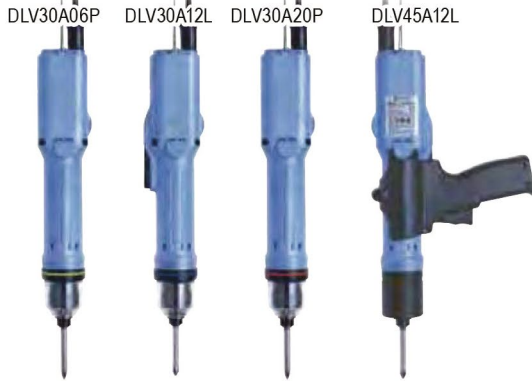

Features

Eco-friendly electric screwdrivers with built-in brushless motors in a transformerless profile

- Torque range from 0.4 to 7.0 Nm
- Speed range from 650 to 2000 min⁻¹
- Both the Lever Start and Push to Start type models are available
- Equipped with a torque adjustment ring cover
- Design conforms to the RoHS Directive and thus appeals to the environmentally conscious user
- Easily detachable Pistol Grip DLW2300 (TD00335) comes with the unit as a standard accessory (DLV45A/70A)

Specifications

		Low Speed	Standard	High Speed	Low Speed	Standard	Low Speed
Model	Bit	DLV30A06L-AB : K	DLV30A12L-AB : K	DLV30A20L-AB : K	DLV45A06L-AB : K	DLV45A12L-AB : K	DLV70A06L-AB : K
	Lever Start	DLV30A06P-AB : K	DLV30A12P-AB : K	DLV30A20P-AB : K	DLV45A06P-AB : K	DLV45A12P-AB : K	DLV70A06P-AB : K
Input Voltage		230 V AC, 50/60 Hz					
Torque Adjustment		Stepless					
Torque (Nm [lbf-in])	Low Torque Spring*1	0.4 - 1.6 [3.5 - 14.2]			2.0 - 4.5 [17.7 - 39.8]		3.8 - 7.0 [33.6 - 62.0]
	High Torque Spring*2	1.2 - 3.0 [10.6 - 26.6]					
Free Speed (min ⁻¹)		650	1200	2000	650	1200	650
Power Consumption (W)		Approx. 45					
Screw Size (mm)	Machine Screw	2.6 - 5.0			4.5 - 6.0		5.0 - 8.0
	Tapping Screw	2.5 - 4.0			4.0 - 5.0		4.5 - 6.0
Mass (g [lbs])		700 [1.54]			870 [1.92] (with Pistol Grip)		
Standard Accessories		• Bit No.2 x 7 x 75 • Suspension Bail		• Low Torque Spring	• Bit No.2 x 7 x 75 • Suspension Bail		

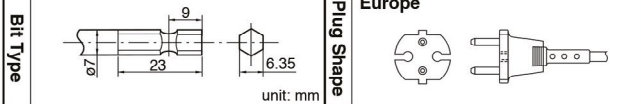

*1: Standard Accessory
*2: Built-in.

Torque Diagrams (for reference)

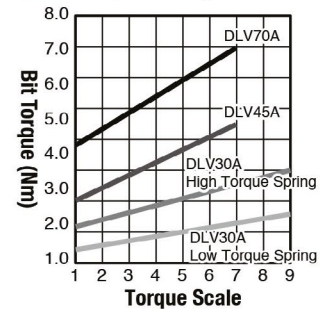

Optional Accessories



External Dimensions

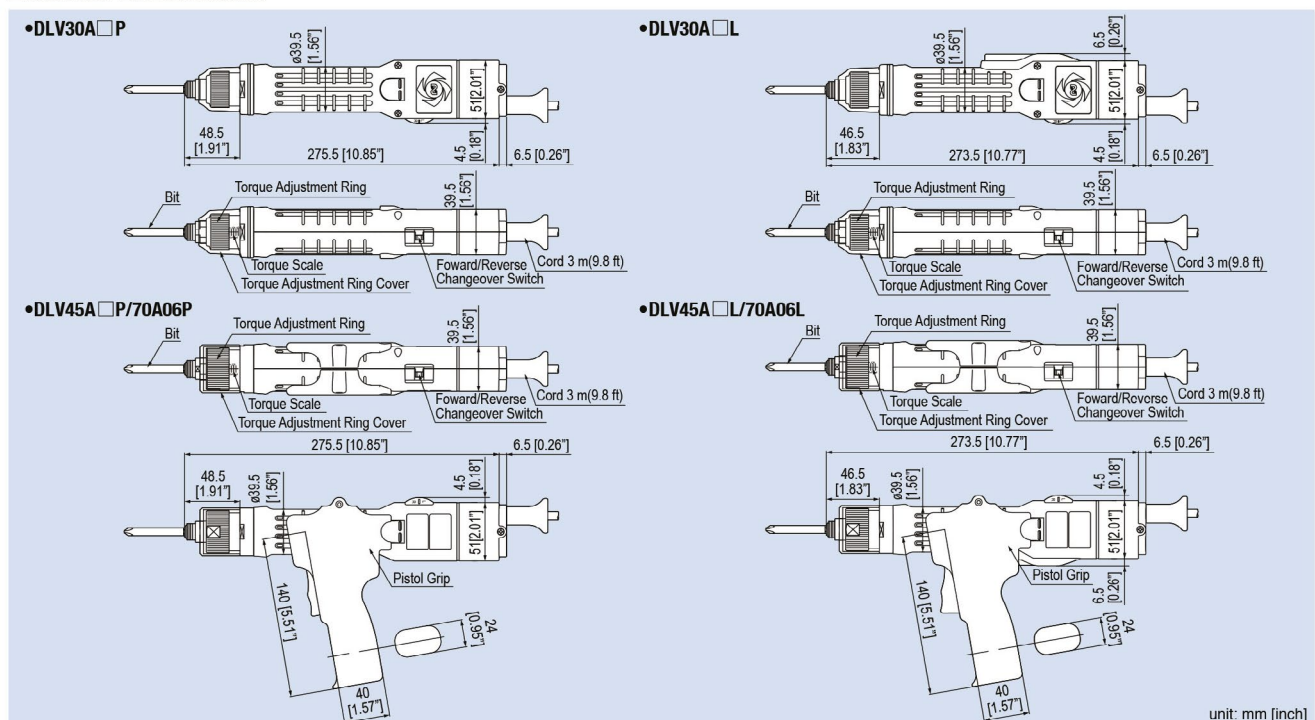

Low Voltage (DC)	
Brush motor	Brushless motor
Miniature screw	Precision screw
Machine screw	
1.0 - 4.0 mm	



Delvo Brushless Type

DLV02/12/16 Series



Features

Brushless motors are incorporated for maximum tool life

- Ergonomic grip offers greater operator comfort and increased maneuverability
- Grounded bit system standard
- Clear plastic torque adjustment cover provided as standard accessory (DLV02/12/16SL-CKE)
- ESD (electrostatic discharge) protection structure (DLV02/12/16SL-BKE)
- Compliant with CE standards
- Controllers feature an overload detection function. When an overload is detected, the controller stops the screwdriver. Operation can be resumed after the screwdriver is unloaded, and the lever released (DLC16S)
- Universal input voltage from 100 to 240 V AC for easy installation (DLC16S)
- Variable speed adjustment enables you to select optimum screw tightening speed (DLC16S)

Specifications

Model	Standard Type	DLV02SL-CKE	DLV12SL-CKE	DLV16SL-CKE
	ESD Protection Type	DLV02SL-BKE	DLV12SL-BKE	DLV16SL-BKE
Starting Method	Lever Start			
Input Voltage	20 - 30 V DC			
Torque Adjustment	Stepless			
Torque (Nm [lbf-in])	0.03 - 0.2 [0.3 - 1.8]	0.15 - 1.2 [1.3 - 10.6]	0.2 - 1.6 [1.8 - 14.2]	
Free Speed (min ⁻¹)	700 - 1000			
Power Consumption (W)	48			
Screw Size (mm)	Machine Screw	1.0 - 2.2	1.4 - 3.0	2.2 - 4.0
	Tapping Screw	1.0 - 2.0	1.4 - 2.6	2.0 - 3.0
Mass (g [lbs])	470 [1.04]			

Model	DLC16S-WGB
Input Voltage	100 - 240 V AC, 50/60 Hz
Output Voltage	20 - 30 V DC
Function	Speed Control
Mass (g [lbs])	380 [0.84]

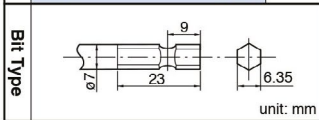
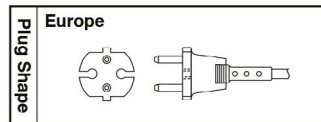

Standard Accessories

Model	DLV02	DLV12	DLV16
Bit	No.0 x 3.8 x 50	1	-
	No.1 x 3.8 x 50	1	1
	No.2 x 4.5 x 50	-	1
Connection Cable	1	1	1

Torque Diagrams (for reference)

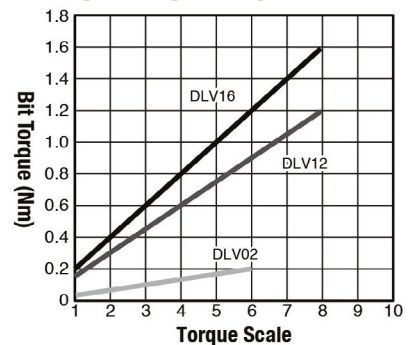

External Dimensions

•DLV02/12/16SL-CKE

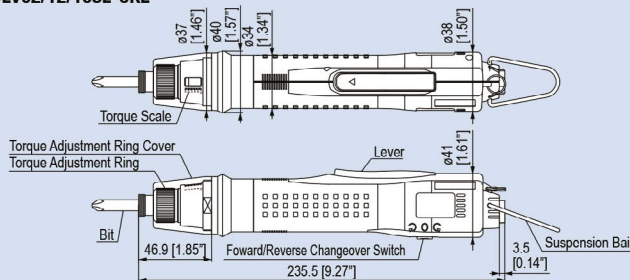

•DLC16S-WGB

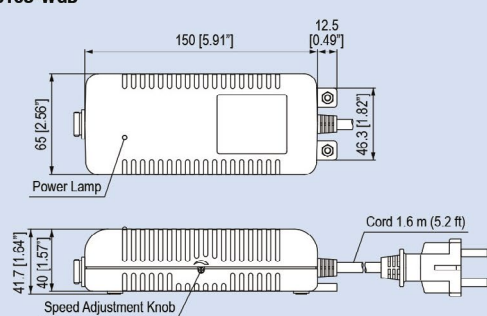

•DLV02/12/16SL-BKE

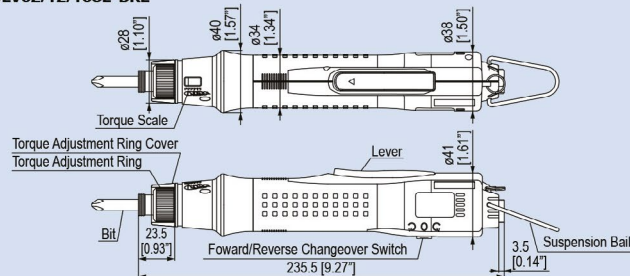

unit: mm [inch]

Low Voltage (DC)
 Brushless motor
 Precision screw
 Machine screw
 1.0 - 2.6 mm



Clean room adaptation
 DLV7419A
 DLV7419HA
 DLV7429A



DLV7400A Series CE



Features

- The light and compact body reduces operator fatigue**
- Reduces shock applied to workpieces when fastening screws
 - ESD (electrostatic discharge) protection structure
 - Lightweight (Standard type 230 g, Clean room type 275 g)
 - The Clean Room Type complies with Class 3 Clean Room Rating
 - The controller can adjust speed (Screw-fastening speed can be set to suit specific fastening conditions)
 - The controller provides a soft start function
 - The initial speed at screwdriver startup can therefore be slowed down, effectively preventing screw heads from being scratched
 - The built-in coreless motor achieves reduced inertia
 - Torque accuracy is within a top-ranked worldwide level (Based on measurements at our laboratory)
 - Compliant with CE standards
 - Use of the Screw Fastening Counter prevents human fastening errors and enhances accurate fastening control (No CE marking or CCC applied)
 - Screw Fastening Counter Model DLR5640-WN works in conjunction with any dedicated SPC-type electric screwdrivers

Specifications

Model	Standard Type	DLV7410A-BME	DLV7410HA-BME	DLV7420A-BME
	Clean Room Type	DLV7419A-BME	DLV7419HA-BME	DLV7429A-BME
Starting Method	Lever Start			
Input Voltage	40 V DC			
Torque Adjustment	Stepless			
Torque (Nm [lbf-in])	0.02 - 0.2 [0.2 - 1.8]		0.15 - 0.4 [1.3 - 3.5]	
Free Speed (min ⁻¹)	500 - 750	700 - 1000	450 - 600	
Power Consumption (W)	Approx. 10			
Screw Size (mm)	Machine Screw	1.0 - 2.3		1.6 - 2.6
	Tapping Screw	1.0 - 2.0		1.4 - 2.3
Mass (g [lbs])	Standard Type 230 [0.51] / Clean Room Type 275 [0.61]			

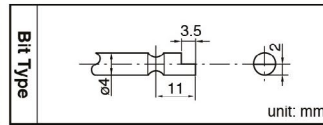

Model	DLC1110-EN	DLC1110-FE	DLC1110-GE	DLC1110-GG	DLC1110-HE	DLC1213A-GGB*1	DLC1213A-HEB*1
Features	Standard	Standard	Standard	With CE Mark	With CE Mark	With CE Mark	Standard
Input Voltage	100 V AC, 50/60 Hz	115 V AC, 50/60 Hz	220 V AC, 50/60 Hz	230 V AC, 50/60 Hz	240 V AC, 50/60 Hz	230 V AC, 50/60 Hz	240 V AC, 50/60 Hz
Control Function	Soft Start, Speed Control, ESD Protected						
Plug Shape	USA	USA	UK	Europe	UK	Europe	UK
Mass (g [lbs])	900 [1.98]			2300 [5.07]			

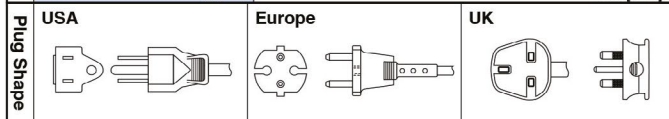

*1: An optional cord is required to connect with this model. Neither DLC1213A-GG nor DLC1213A-HE can be used with the DLV7400A series.

Model DLC1213A-GGB or DLC1213A-HEB + Cord DLW9072

Standard Accessories

Model	DLV7410A/DLV7410HA	DLV7420A	DLV7419A/DLV7419HA	DLV7429A
Bit	No.0 x 1.8 x 44	1	-	1
	No.0 x 2.5 x 44	1	1	1
	No.1 x 4 x 44	-	1	-
Connection Cable DLW9070	1	1	1	1
Spring for Low Torque	1	-	1	-
Suspension Bail	1	1	1	1
Sleeve for Vacuum DLS2124	-	-	1	1

Optional Accessories



* Please see page 39 for details.

Shock value

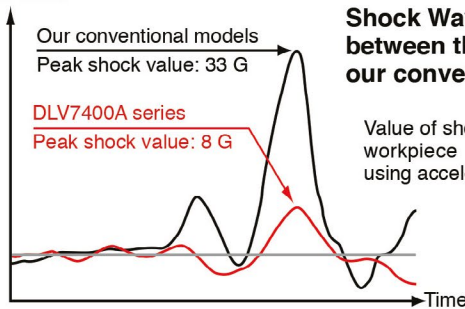

Shock Waveform Comparison between the 7400A series and our conventional models

Value of shock applied to the workpiece as measured using acceleration pickup.

Torque Diagrams (for reference)

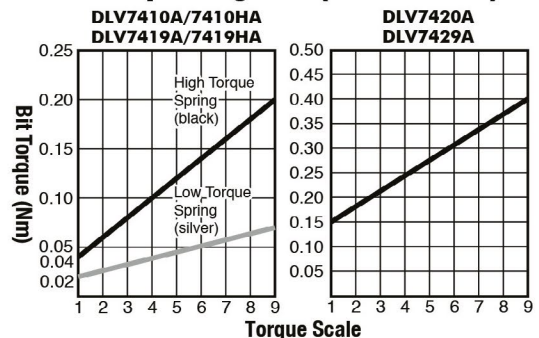

External Dimensions

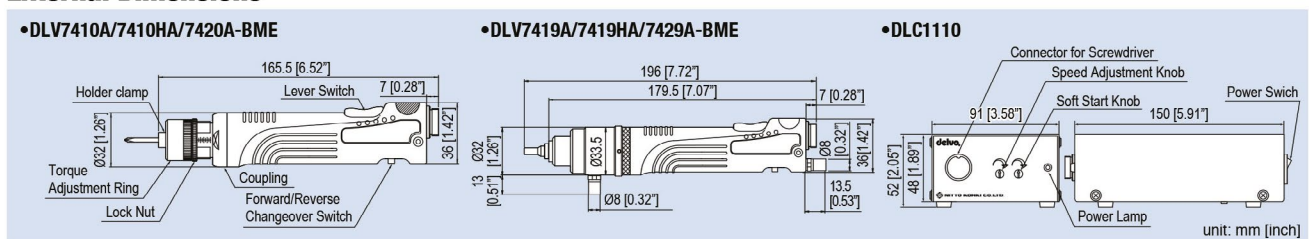

Low Voltage (DC)
 Brush motor Brushless motor
 Miniature screw Precision screw Machine screw
 1.0 - 3.0 mm



DLV5700 Series Non-CE



Features

For quality improvement and productivity enhancement

- Grounded bit installation mechanism
- ESD (electrostatic discharge) protection structure
- Low-shock for tightening (30 % less of standard models)
- Low swing bit mechanism
- Ergonomic design
- High-performance DC motor
- New clutch mechanism

Specifications

Model	DLV5720	DLV5720H	DLV5740	DLV5740H	DLV5750
Starting Method	Lever Start				
Input Voltage	40 V DC			36 V DC	
Torque Adjustment	Stepless				
Torque (Nm [lbf-in])	0.02 - 0.2 [0.2 - 0.18]		0.15 - 0.4 [1.3 - 3.5]		0.1 - 0.55 [0.9 - 4.9]
Free Speed (min ⁻¹)	500 - 750	700 - 1000	450 - 600	1200 - 1800	670 - 1000
Power Consumption (W)	Approx. 10			Approx. 35	
Screw Size (mm)	Machine Screw	1.0 - 2.3		1.6 - 2.6	
	Tapping Screw	1.0 - 2.0		1.4 - 2.3	
Mass (g [lbs])	230 [0.51]			300 [0.66]	
Standard Accessories	<ul style="list-style-type: none"> • Bit No.0 × 1.8 × 44 • Bit No.0 × 2.5 × 44 • Connection Cable (1.5 m)DLW9081 • Suspension Bail • Spring for Low Torque 		<ul style="list-style-type: none"> • Bit No.0 × 2.5 × 44 • Bit No.1 × 4 × 44 	<ul style="list-style-type: none"> • Connection Cable (1.5 m)DLW9081 • Suspension Bail 	

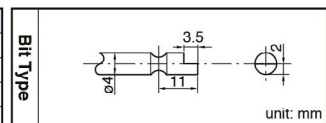

Model	DLC0350E	DLC0350F	DLC0350G	DLC0950E	DLC0950G
Input Voltage	100 V AC, 50/60 Hz	115 V AC, 50/60 Hz	230 V AC, 50/60 Hz	100 V AC, 50/60 Hz	230 V AC, 50/60 Hz
Plug Shape	USA		UK	USA	
Mass (g [lbs])	900 [1.98]			1800 [3.97]	

Optional Accessories

Sleeve
DLP5300 (TD04342)

Vacuum Pickup
DLP5300 (TD04342)

Torque Adjustment Ring Cover
DLW5700 (TD02875)

This minimizes tampering or accidental turning of the torque adjustment ring once the torque is set.

* Please see page 39 for details.

Torque Diagrams (for reference)

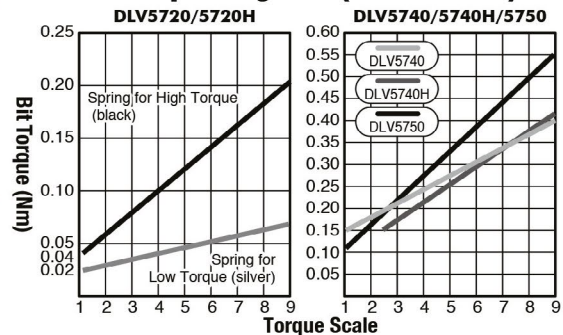

External Dimensions

•DLV5720/5720H/5740

•DLV5740H/5750

•DLC0350

•DLC0950

unit: mm [inch]

Low Voltage (DC)		
Brush motor	Brushless motor	
Miniature screw	Precision screw	Machine screw
1.0 - 2.6 mm		

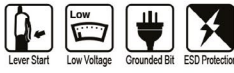

delvo

DLV5800 Series Non-CE

DLV5800 series



DLC0250E



DLC0350



Features

In response to the needs of cell production system, space-saving delvo screwdrivers are released. Controller is designed for emphasis on space-saving size and lightness.

- Clear disengagement of clutch (low-shock mechanism unavailable)
- Grounded bit installation mechanism
- ESD (electrostatic discharge) protection structure
- New lever is adopted
- Low swing bit mechanism
- Low voltage transformerless controller

Specifications

Model	DLV5820		DLV5820H	DLV5840
	Starting Method	Lever Start		
Input Voltage	40 V DC			
Torque Adjustment	Stepless			
Torque (Nm [lbf-in])	0.02 - 0.2 [0.2 - 1.8]			0.15 - 0.4 [1.3 - 3.5]
Free Speed (min ⁻¹)	750		1000	600
Power Consumption (W)	Approx. 10			
Screw Size (mm)	Machine Screw		1.0 - 2.3	1.6 - 2.6
	Tapping Screw		1.0 - 2.0	1.4 - 2.3
Mass (g [lbs])	230 [0.51]			
Cord Length (m)	1.5 (with connector)			
Grounding Bit Feature	Equipped as standard			
Standard Accessories	• Bit No.0 × 1.8 × 44		• Connection Cable (1.5 m)	• Bit No.0 × 2.5 × 44
	• Bit No.0 × 2.5 × 44		• Spring for Low Torque (Silver)	• Bit No.1 × 4 × 44
	• Suspension Bail			• Suspension Bail
				• Connection Cable (1.5 m)

Model	DLC0250E
Input Voltage	100 V AC, 50/60 Hz
Function	Grounded Bit Installation Mechanism
Mass (g [lbs])	300 [0.66]
Case Material	Antistatic material

USA
Plug Shape

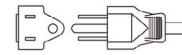

* Electric screwdrivers DLV5800 series can be also used with DLC0350.

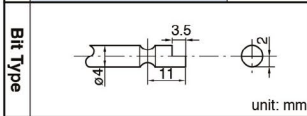

Optional Accessories

Sleeve

Vacuum Pickup
DLP5300 (TD04342)

Torque Adjustment Ring Cover
DLW5700 (TD02875)

This minimizes tampering or accidental turning of the torque adjustment ring once the torque is set.

* Please see page 39 for details.

Torque Diagrams (for reference)

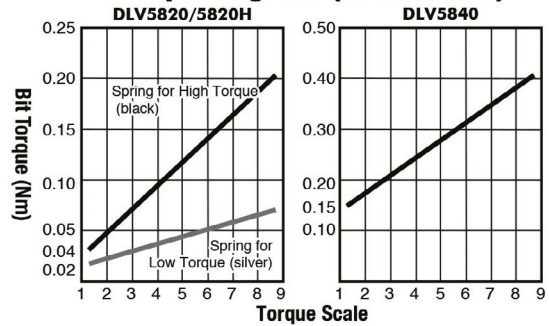

External Dimensions

•DLV5820/5820H/5840

Dimensions: 165.5 [6.52"], 108 [4.25"], 68 [2.68"], 40 [1.57"], 36 [1.42"], 32 [1.26"]

Labels: Torque Adjustment Ring, Holder clamp, Lock Nut, Coupling, Lever switch, Forward/Reverse Changeover Switch

•DLC0250E

Dimensions: 108 [4.25"], 68 [2.68"], 40 [1.57"]

Label: Connection cable 1.5 m (4.9 ft)

unit: mm [inch]

Low Voltage (DC)		
Brush motor	Brushless motor	
Miniature screw	Precision screw	Machine screw
1.0 - 3.5 mm		

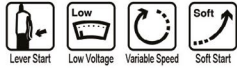

Delvo

DLV7300 Series

DLV7313/7323/7333

DLV7325/7335



DLC1213A



Features

- The dedicated controller realizes high-accuracy screw tightening
- High repeatable torque accuracy
- The controller provides a soft start function. The initial speed at screwdriver startup can therefore be slowed down, effectively preventing screw heads from being scratched.
- Variable speed adjustment enables to select optimum screw tightening speed.
- DLV7325, DLV7335 meet Class 5*1 Clean Room standards

*1: Based on Nitto Kohki's standard of measurement

Specifications

Model	Bit Shank: $\phi 4$ mm Bit Shank: Hex. 6.35 mm	Standard			Clean Room Use		
		DLV7313-CME	DLV7323-CME	DLV7333-CME	DLV7325-CME*2	DLV7335-CME*2	
Electric Screwdriver	Starting Method	Lever Start					
	Input Voltage	36 V DC					
	Torque Adjustment	Stepless					
	Torque (Nm [lbf-in])	0.03 - 0.15 [0.3 - 1.3]	0.05 - 0.5 [0.4 - 4.4]	0.3 - 1.2 [2.7 - 10.6]	0.05 - 0.5 [0.4 - 4.4]	0.3 - 1.2 [2.7 - 10.6]	
	Free Speed (min ⁻¹)	700 - 1000					
	Power Consumption (W)	Approx. 35					
	Screw Size (mm)	Machine Screw	Up to 2.0	1.0 - 3.0	2.0 - 3.5	1.0 - 3.0	2.0 - 3.5
		Tapping Screw	Up to 1.7	1.2 - 2.6	2.0 - 3.0	1.2 - 2.6	2.0 - 3.0
	Mass (g [lbs])	350 [0.77]			400 [0.88]		

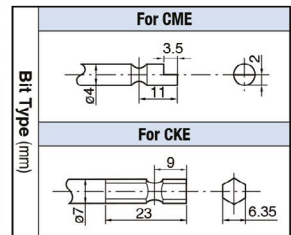

*2: Vacuum pump for suction of screw is available as option. See page 31 for details of the vacuum pump.

Model	Features	Input Voltage	Control Function	Plug Shape	Mass (g [lbs])
DLC1213A-EN	Standard	100 V AC, 50/60 Hz	Soft start, Speed control	Asia	2300 [5.07]
DLC1213A-FE*3	Standard	115 V AC, 50/60 Hz		UK	
DLC1213A-GE	Standard	220 V AC, 50/60 Hz		Europe	
DLC1213A-GG	With CE Mark	230 V AC, 50/60 Hz		UK	
DLC1213A-GGU	With CE Mark	230 V AC, 50/60 Hz		Without Plug	
DLC1213A-HE	Standard	240 V AC, 50/60 Hz			

*3: This model is made to order.

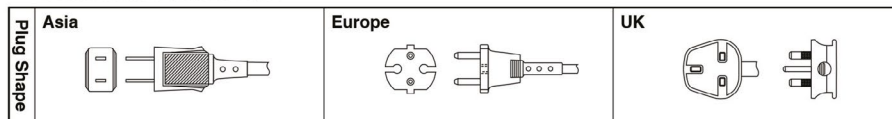

Torque Diagrams (for reference)

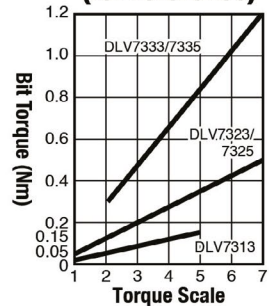

Standard Accessories

Model	DLV7313 -CME	DLV7323 -CME	DLV7333 -CME	DLV7323 / 31 / 33-CKE	DLV7325 -CME	DLV7335 -CME	DLV7325 / 35-CKE
Bit	No.0 x 1.8 x 44	1	-	-	-	-	-
	No.0 x 2.5 x 44	1	-	-	1	-	-
	No.1 x 3 x 44	-	-	1	-	-	1
	No.1 x 4 x 44	-	1	-	-	1	-
	No.1 x 7 x 50	-	-	-	1	-	-
	No.2 x 4 x 44	-	-	1	-	-	1
	No.2 x 4.5 x 50	-	-	-	-	-	1
Sleeve	DLS2124	-	-	-	1	-	-
	DLS2127	-	-	-	1	1	-
	DLS2130	-	-	-	-	1	-
	DLS2134	-	-	-	-	1	-
	DLS2135	-	-	-	-	-	1
Suspension Bail				1			

Optional Accessories



This minimizes tampering or accidental turning of the torque adjustment ring once the torque is set.

Torque Adjustment Ring Cover for DLV7303 DLW5500 (TD00333)

External Dimensions

•DLV7313/7323/7333

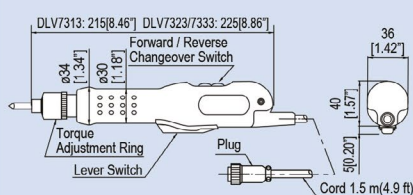

•DLV7325/7335

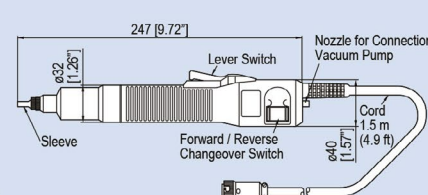

•DLC1213A

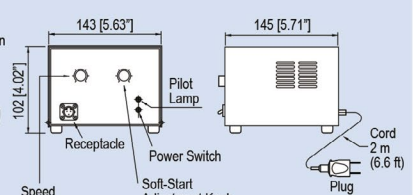

unit: mm [inch]

Low Voltage (DC)	
Brush motor	Brushless motor
Miniature screw	Precision screw
Machine screw	
1.0 - 3.5 mm	



delvo

DLV7300-BME/BKE Series



Features

Workpiece-conscious electric screwdrivers

- Static electricity buildup is prevented to protect workpieces from electrostatic discharge
- Minimal impact in screw tightening protects workpieces from damaging and enables stable screw tightening
- ESD (electrostatic discharge) protection structure
- Meet Class 5^{†1} or more Clean Room standards

*1: Based on Nitto's standard of measurement

Specifications

Model	Bit Shank: ϕ 4 mm Bit Shank: Hex. 6.35 mm	ESD		ESD / Low Shock			
		DLV7321-BME*2	DLV7331-BME*2	DLV7319-BME*2	DLV7329-BME*2	DLV7339-BME	DLV7349-BME*2
Starting Method		Lever Start					
Input Voltage		36 V DC					
Torque Adjustment		Stepless					
Torque (Nm [lbf-in])		0.05 - 0.5 [0.4 - 4.4]	0.3 - 1.2 [2.7 - 10.6]	0.2 - 0.4 [1.8 - 3.5]	0.25 - 0.4 [2.2 - 4.9]	0.45 - 0.95 [4.0 - 8.4]	0.55 - 1.2 [4.9 - 10.6]
Free Speed (min ⁻¹)		700 - 1000	500 - 700	700 - 1000		500 - 700	
Power Consumption (W)		Approx. 35					
Screw Size		Machine Screw		2.0 - 3.0		3.0 - 3.5	
		Tapping Screw		2.0 - 2.6		2.6 - 3.0	
Mass (g [lbs])		350 [0.77]			400 [0.88]		

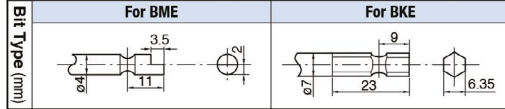

*2: These models are made to order.

Model	Features	Input Voltage	Plug Shape	Control	Mass (g [lbs])	Europe	UK	USA
DLC1213A-ENB	Standard	100 V AC, 50/60 Hz	USA	Grounding, Soft Start, Speed Control	2300 [5.07]			
DLC1213A-FEB*3	Standard	115 V AC, 50/60 Hz	USA					
DLC1213A-GBB	With CE mark	230 V AC, 50/60 Hz	Europe					
DLC1213A-HEB	Standard	240 V AC, 50/60 Hz	UK					

*3: This model is made to order.

Measurement Point	Conventional Product	DLV7300-B <input type="checkbox"/> E <input type="checkbox"/>	Part	Material
Handle	Static Electricity (V)	350	Handle Lever Switch	Synthetic resin with carbon fiber
	Surface Resistance (Ω)	more than 10^{13}	Power Cable	Anti-static material
Lever Switch	Static Electricity (V)	350	* Measurement conditions (Temperature: 22 °C Humidity: 66 %)	
	Surface Resistance (Ω)	more than 10^{13}	(1) Static electricity - Earth the measurement equipment and measuring person.	
Forward / Reverse Switch	Static Electricity (V)	25	- Grip the screwdriver five times using Ansel Edmont electronic control glove.	
	Surface Resistance (Ω)	more than 10^{13}	- Turn on the switch of the screwdriver. - Measure each part of the screwdriver using electronic measurement equipment manufactured by Shishido electrostatic Ltd.	
Power Cable	Static Electricity (V)	110	(2) Surface resistance - Measure using Simco Japan surface resistivity measurement equipment.	
	Surface Resistance (Ω)	more than 10^{13}		

Standard Accessories

Model	DLV7319/29 -BME	DLV7339/49 -BME	DLV7321 -BME	DLV7331 -BME	DLV7321/31 -BKE	
Bit	No.0 x 2.5 x 44	1	1	-	-	
	No.1 x 3 x 44	-	1	-	-	
	No.1 x 4 x 44	1	-	1	-	
	No.1 x 7 x 50	-	-	-	-	1
	No.2 x 4 x 44	-	1	-	1	-
	No.2 x 7 x 50	-	-	-	-	1
Sleeve	DLS2124	1	-	-	-	
	DLS2127	1	1	-	-	
	DLS2130	1	1	-	-	
	DLS2134	-	1	-	-	
Suspension Bail	1					

Torque Diagrams (for reference)

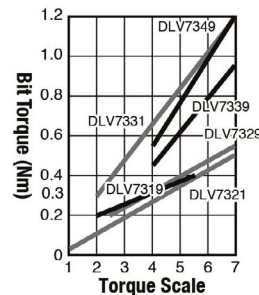

External Dimensions

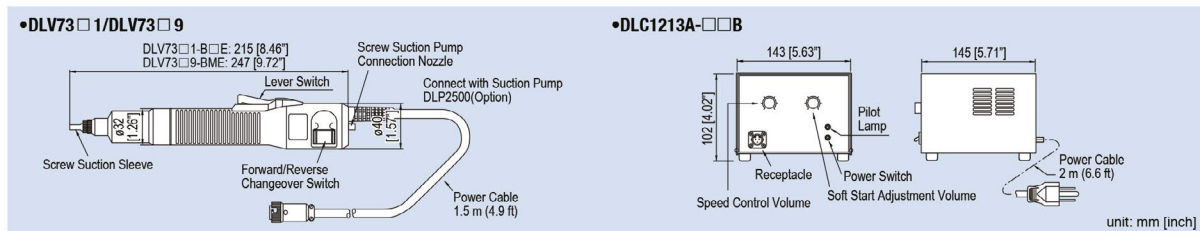

Low Voltage (DC)
 Brush motor / Brushless motor
 Miniature screw / Precision screw / Machine screw
 2.6 - 6.0 mm



delvo

DLV7500/8500 Series

DLV7500-MKE DLV7550-MKE DLV8500-BKE DLV8550-MKE



Features

- Low vibration, low noise, and easy gripping in a compact design
- The easily visible torque reach light goes on when the set torque is reached
- The combination of an advanced clutch design and the auto-stop circuit assures torque accuracy
- The long life motor with a yoke made of advanced materials further assures a long service life
- Compliant with CE standard
- ESD (electrostatic discharge) protection structure (DLV7500/8500-BKE)

Specifications

Model	Standard Type	Standard		High Torque	Standard		High Torque
	ESD Protection Type	DLV7530-MKE	DLV7540-MKE	DLV7550-MKE	DLV8530-MKE	DLV8540-MKE	DLV8550-MKE
Starting Method		Lever Start			Push to Start		
Input Voltage		59 V DC					
Torque Adjustment		Stepless					
Torque (Nm [lbf-in])		0.5 - 1.7 [4.4 - 15.1]	1.2 - 2.7 [10.6 - 23.9]	2.0 - 4.5 [17.7 - 39.8]	0.5 - 1.7 [4.4 - 15.1]	1.2 - 2.7 [10.6 - 23.9]	2.0 - 4.5 [17.7 - 39.8]
Free Speed (min ⁻¹)		1100	700	500	1100	700	500
Screw Size	Machine Screw	2.6 - 4.0	3.5 - 5.0	4.5 - 6.0	2.6 - 4.0	3.5 - 5.0	4.5 - 6.0
	Tapping Screw	2.3 - 3.5	3.0 - 4.0	4.0 - 5.0	2.3 - 3.5	3.0 - 4.0	4.0 - 5.0
Mass (g [lbs])		650 [1.43]		750 [1.65]	650 [1.43]		750 [1.65]

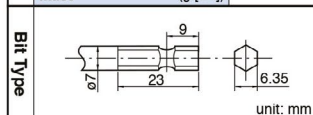

Measurement Point	Conventional Product	DLV7500/8500-BKE	
Handle	Static Electricity (V)	350	5
	Surface Resistance (Ω)	more than 10 ¹³	10 ⁴
Lever Switch	Static Electricity (V)	350	2
	Surface Resistance (Ω)	more than 10 ¹³	10 ⁴
Forward / Reverse Switch	Static Electricity (V)	25	2
	Static Electricity (V)	110	5
Connection Cable	Static Electricity (V)	110	5
	Surface Resistance (Ω)	more than 10 ¹³	10 ¹⁰

Part	Material
Handle Lever Switch	Synthetic resin with carbon fiber
Power Cable	Anti-static material

* Measurement conditions (Temperature: 22 °C Humidity: 66 %)
 (1) Static electricity - Earth the measurement equipment and measuring person.
 • Grip the screwdriver five times using Ansel Edmont electronic control glove.
 • Turn on the switch of the screwdriver. • Measure each part of the screwdriver using electronic measurement equipment manufactured by Shishido electrostatic Ltd.
 (2) Surface resistance • Measure using Simco Japan surface resistivity measurement equipment.

Standard Accessories

Model	DLV7530 / 7540 / 8530 / 8540	DLV7550 / 8550	
Bit	No.1 × 7 × 75	1	-
	No.2 × 7 × 75	1	1
	No.3 × 7 × 50	-	1
Spare Carbon Brush		2	
Connection Cable		1	
Suspension Bail		1	

Torque Diagrams (for reference)

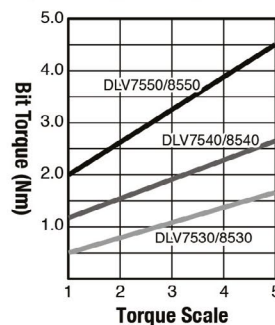

External Dimensions

•DLV7500 series

•DLV8500 series

unit: mm [inch]



DLC4511-GGB



DLR1510-JE

Specifications

Model	DLC4511-GGB	DLR1510-JE
Controller	Function Stepless speed adjustment 80 - 100 % Soft start: adjustable time setting of slow speed (max. 3 sec.) External output signals: start and torque up Electro-static discharge(ESD) control	Screw counting: OK lamp and buzzer for notification Variable non-operation time Setting protection by key lock switch Setting by touch switch for easy operation External output signals: Start, Torque up, Count up & Cycle OK
	Input Voltage	230 V AC, 50/60 Hz
Mass (g [lbs])	3500 [7.72]	5100 [11.24]
Plug Shape	Europe 	

External Dimensions

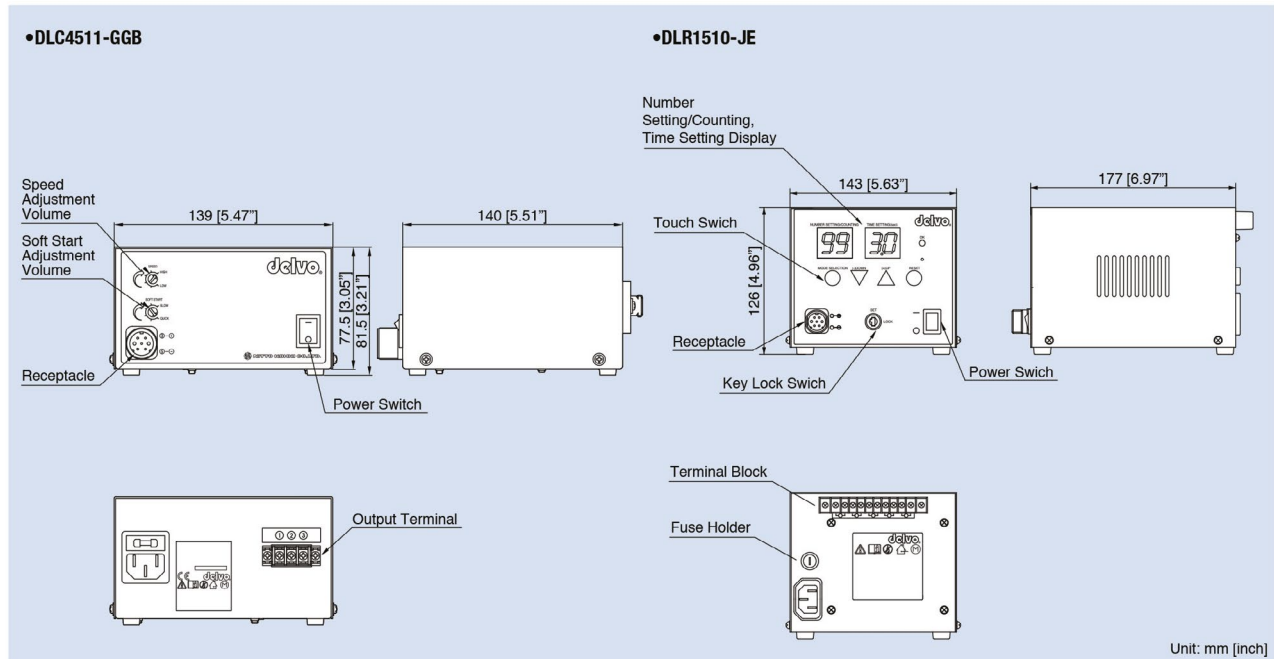

Transformerless (AC)		
Brush motor	Brushless motor	
Miniature screw	Precision screw	Machine screw
1.0 - 3.5 mm		



DLV7000/8000 Series Non-CE



Features

100 / 115 V AC Direct Transformerless Precision Miniature Screw Type

- A built-in controller model saves space and facilitates layout change
- High repetitive torque accuracy
- Available with lever type (DLV7000 series) for each screw alignment and push to start type (DLV8000 series) for rapid screw tightening
- The high-speed type (DLV7031/8031) available at 1200 min⁻¹ for improving work efficiency (100 V AC only)

Specifications

Electric Screwdriver	Model	Standard				High Speed	
		DLV7020-EMN DLV7020-FME*1	DLV7030-EMN DLV7030-FME*1	DLV8020-EMN DLV8020-FME*1	DLV8030-EMN DLV8030-FME*1	DLV7031-EMN	DLV8031-EMN
	100 V AC Input 115 V AC Input						
	Starting Method	Lever Start		Push to Start		Lever Start	Push to Start
	Torque Adjustment	Stepless					
	Torque (Nm [lbf-in])	0.05 - 0.55 [0.4 - 4.9]	0.3 - 1.1 [2.7 - 9.7]	0.1 - 0.55 [0.9 - 4.9]	0.3 - 1.1 [2.7 - 8.9]	0.3 - 1.0 [2.7 - 8.9]	
	Free Speed (min ⁻¹)	900	650	900	650	1200	
	Power Consumption (W)	Approx. 25					
	Screw Size (mm)	Machine Screw	2.0 - 3.5	1.0 - 3.0	2.0 - 3.5	2.0 - 3.0	
		Tapping Screw	1.2 - 2.6	2.0 - 3.0	1.2 - 2.6	2.0 - 3.0	2.0 - 3.0
	Mass (g [lbs])	400 [0.88]		410 [0.90]		400 [0.88]	410 [0.90]
Bit Type	 unit: mm	Asia		*1: These models are made to order.			
		 Plug Shape					

Standard Accessories

Model	DLV7020 / 8020	DLV7030 / 8030 / 7031 / 8031
Bit	No.0 × 2.5 × 44	1
	No.1 × 3 × 44	-
	No.1 × 4 × 44	1
	No.2 × 4 × 44	-
Spare Carbon Brush	1	

Torque Diagrams (for reference)

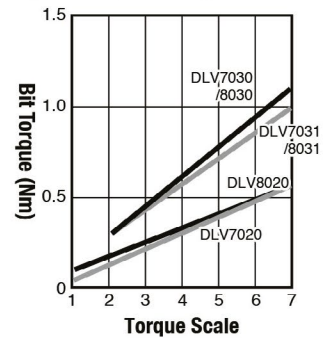

Optional Accessories

This minimizes tampering or accidental turning of the torque adjustment ring once the torque is set.
Torque Adjustment Ring Cover
 DLW5300 (TD00332)

External Dimensions

•DLV7020/7030/7031

Forward/Reverse Changeover Switch
Cord 3 m (9.8 ft)
Lever Switch
Torque Adjustment Ring
236 [9.29"]

•DLV8020/8030/8031

Forward/Reverse Changeover Switch
Cord 3 m (9.8 ft)
Torque Adjustment Ring
240 [9.45"]

unit: mm [inch]

Transformerless (AC)
 Brush motor Brushless motor
 Miniature screw Precision screw Machine screw
 2.6 - 6.0 mm



115V

Jelvo

DLV7100/7200/8100/8200 Series Non-CE



Features

Long Time Selling, Reliable, and High Performance

- Transformerless space saving model built in automatic stop circuit
- Combination of unique clutch mechanism and automatic stop circuit maintains high repetitive torque accuracy
- The lever start type DLV7100 / 7200 series is suited for temporarily tightening screws and tightening screws set at angles
- The DLV8100 / 8200 series is push to start type for continuous screw tightening
- The high speed type DLV7200 / 8200 series enhances working efficiency
- The high torque type DLV7251 / 8150 / 8251 series is equipped with a grip, which is useful for tightening big screws like 6 mm machine screws

Specifications

Model	Bit Shank: Hex. 5 mm (0.2") Bit Shank: Hex. 6.35 mm (1/4")	Standard			High Speed			High Torque	Standard			High Torque	High Speed			High Torque
		DLV7120-FJE	DLV7130-FJE	DLV7140-FJE	DLV7221-FJE	DLV7231-FJE	DLV7241-FJE	DLV7251-FKE	DLV8120-FJE	DLV8130-FJE	DLV8140-FJE	DLV8150-FJE	DLV8221-FJE	DLV8231-FJE	DLV8241-FJE	DLV8251-FKE
Starting Method		Lever Start							Push to Start							
Input Voltage		115 V AC, 50/60 Hz														
Torque Adjustment		Stepless														
Torque	(Nm)	0.35 - 0.70	0.5 - 1.7	1.2 - 3.0	0.35 - 0.70	0.5 - 1.7	1.2 - 3.0	2.0 - 4.5	0.35 - 0.70	0.5 - 1.7	1.2 - 3.0	2.0 - 4.5	0.35 - 0.70	0.5 - 1.7	1.2 - 3.0	2.0 - 4.5
	[lbf-in]	[3.10 - 6.20]	[4.4 - 15.1]	[10.6 - 26.6]	[3.10 - 6.20]	[4.4 - 15.1]	[10.6 - 26.6]	[17.7 - 39.8]	[3.10 - 6.20]	[4.4 - 15.1]	[10.6 - 26.6]	[17.7 - 39.8]	[3.10 - 6.20]	[4.4 - 15.1]	[10.6 - 26.6]	[17.7 - 39.8]
Free Speed	(min ⁻¹)	900	900	600	1800	1800	1100	700	900	900	600	400	1800	1800	1100	700
Power Consumption	(W)	Approx. 35			Approx. 45				Approx. 35			Approx. 45				
Screw Size	Machine Screw	2.6 - 3.0	2.6 - 4.0	3.5 - 5.0	2.6 - 3.0	2.6 - 4.0	3.5 - 5.0	4.5 - 6.0	2.6 - 3.0	2.6 - 4.0	3.5 - 5.0	4.5 - 6.0	2.6 - 3.0	2.6 - 4.0	3.5 - 5.0	4.5 - 6.0
	Tapping Screw	2.6 - 3.0	2.3 - 3.5	3.5 - 4.0	2.6 - 3.0	2.3 - 3.5	3.0 - 4.0	4.5 - 5.0	2.6 - 3.0	2.3 - 3.5	3.5 - 4.0	4.5 - 5.0	2.6 - 3.0	2.3 - 3.5	3.0 - 4.0	4.0 - 5.0
Mass	(g [lbs])	700 [1.54]			890 [1.96]				690 [1.52]			890 [1.96]				

Bit Type (mm)	For FJE		For FKE		Plug Shape
	14	24	9	6.35	

* All models of FJE / FKE series are made to order.

Standard Accessories

Model	FJE	FKE except DLV7251 / 8150 / 8251-FKE	DLV7251 / 8150 / 8251-FKE
Bit	No.1 × 6 × 70	1	-
	No.1 × 7 × 75	-	1
	No.2 × 6 × 70	1	-
	No.2 × 7 × 75	-	1
	No.3 × 7 × 50	-	1
Spare Carbon Brush			2
Suspension Bail			1

Torque Diagrams (for reference)

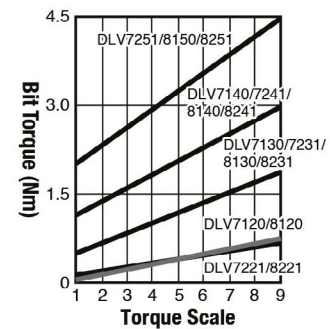

External Dimensions

•DLV7120/7130/7140/7221/7231/7241

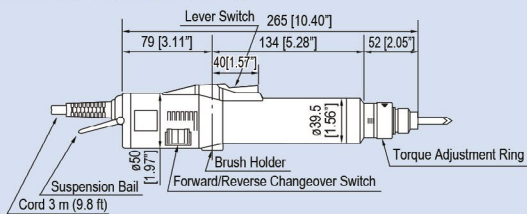

•DLV8120/8130/8140/8221/8231/8241

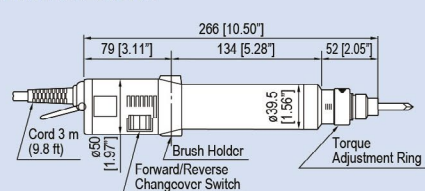

•DLV7251

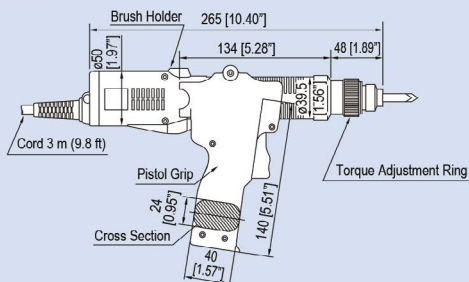

•DLV8150/8251

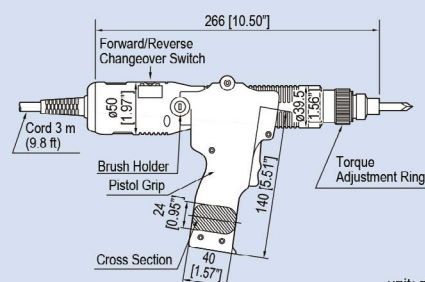

unit: mm [inch]

Transformerless (AC)
 Brush motor Brushless motor
 Miniature screw Precision screw Machine screw
 2.6 - 6.0 mm



DLV7104/8104/8204 Series Non-CE



Features

The most popular models have been redesigned

- Equipped with bit grounding mechanism
- Long-life cam is utilized
- The clear plastic torque adjustment ring cover minimizes unintentional tampering of the preset torque
- The changeover switch enables operators to change forward/reverse rotation with a single hand
- The ergonomically designed grip can be held tightly to resist against tightening reaction force, resulting in reduced operator fatigue

Specifications

Model	Plug Shape: USA	Standard						High Torque	High Speed		
		DLV7124-MKE	DLV7134-MKE	DLV7144-MKE	DLV8124-MKE	DLV8134-MKE	DLV8144-MKE	DLV8154-MKE	DLV8224-MKE	DLV8234-MKE	DLV8244-MKE
	Plug Shape: UK	DLV7124-MKH	DLV7134-MKH	DLV7144-MKH	DLV8124-MKH	DLV8134-MKH	DLV8144-MKH	DLV8154-MKH	DLV8224-MKH	DLV8234-MKH	DLV8244-MKH
Starting Method		Lever Start						Push to Start			
Input Voltage		230 V AC, 50/60 Hz									
Torque Adjustment		Stepless									
Torque	(Nm) [lbf-in]	0.25 - 0.75 [2.2 - 6.6]	0.5 - 1.7 [4.4 - 15.1]	1.2 - 3.0 [10.6 - 26.6]	0.25 - 0.75 [2.2 - 6.6]	0.5 - 1.7 [4.4 - 15.1]	1.2 - 3.0 [10.6 - 26.6]	2.0 - 4.5 [17.7 - 39.8]	0.35 - 0.7 [3.1 - 6.2]	0.5 - 1.7 [4.4 - 15.1]	1.2 - 3.0 [10.6 - 26.6]
Free Speed	(min ⁻¹)	900		600	900		600	400	2000	1800	1100
Power Consumption	(W)	35						45			
Screw Size	Machine Screw	2.6 - 3.0	2.6 - 4.0	3.5 - 5.0	2.6 - 3.0	2.6 - 4.0	3.5 - 5.0	4.5 - 6.0	2.6 - 3.0	2.6 - 4.0	3.5 - 5.0
	Tapping Screw	2.3 - 3.0	2.3 - 3.5	3.0 - 4.0	2.3 - 3.0	2.3 - 3.5	3.0 - 4.0	4.5 - 5.0	2.3 - 3.0	2.3 - 3.5	3.0 - 4.0
Mass	(g [lbs])	720 [1.59]			710 [1.57]			910 [2.01]	710 [1.57]		

Bit Type	Plug Shape	For MKE		For MKH	
		USA	UK	USA	UK

Please contact us for 5 mm bit type.

Standard Accessories

Model	MKE/MKH	8154-MKE/MKH	
Bit	No.1 x 7 x 75	1	-
	No.2 x 7 x 75	1	1
	No.3 x 7 x 50	-	1
Spare Carbon Brush		2	
Suspension Bail		1	

Torque Diagrams (for reference)

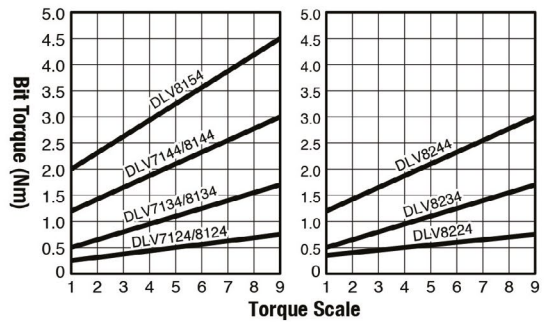

External Dimensions

•DLV7124 / 7134 / 7144

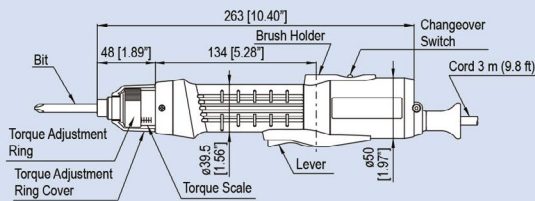

•DLV8154

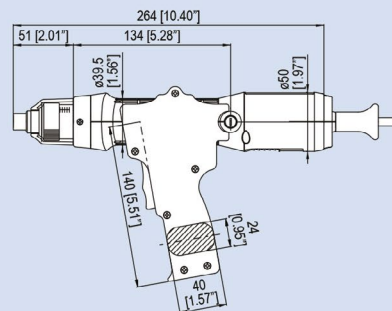

•DLV8124 / 8134 / 8144 / 8224 / 8234 / 8244

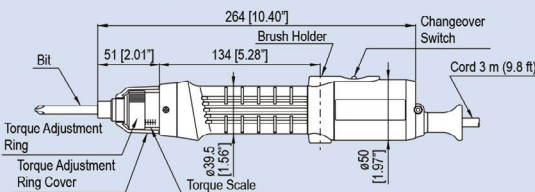

unit: mm [inch]

Screw Fastening Counter Series

Prevents human error with various functions. * Special models available on request

The error is detected based on the set tightening time.

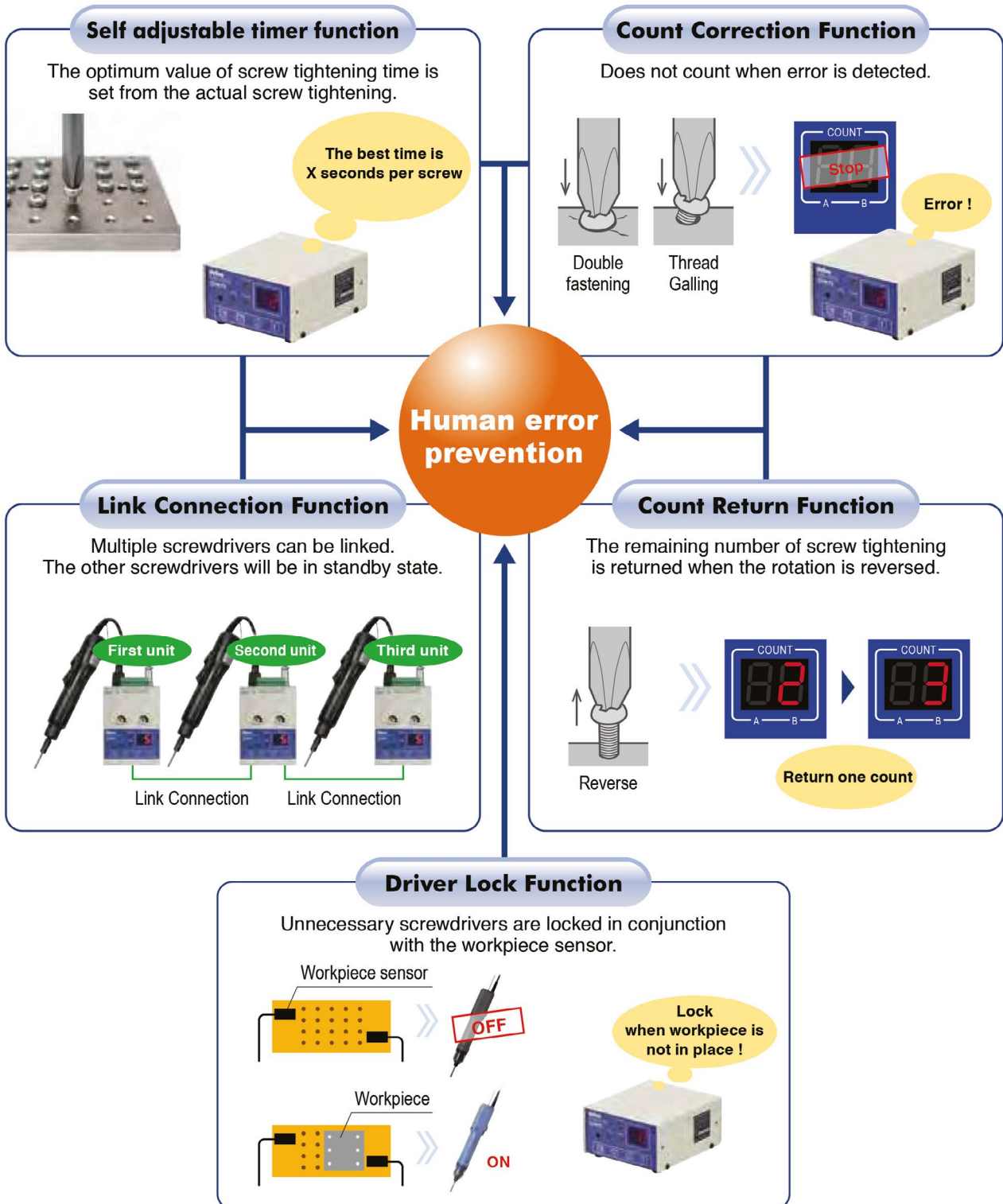



Features

The self-adjustable timer function automatically assesses the time required to complete fastening each screw and reflects it on the judging time setting

- Ideally suited for the assembly lines of vehicles and electrical equipment requiring reliable screw fastening
- The controller receives signals from electric screwdrivers to provide highly reliable screw fastening control
- Functions of the controller and counter are integrated into a single unit
- Count Return Function: When a screw is loosened, a reverse signal output from the electric screwdriver reverses the count by one
- The self-adjustable timer function automatically assesses the time required to complete tightening each screw and reflects it on the judging time setting
- The Count Correction Function does not count elevated screws or double fastening as fastening errors
- External Count Function: To be available to various assembling jobs, the DLR5640 enables counting of two kinds of parts (up to 9 counts each) in addition to the screw tightening counting. These kinds of counting can be used together.
- Link Connection Function: You can build up a simple sequential screw tightening system by connecting the DLR5640 screw tightening counters in series without using any external controller such as a programmable controller
- Driver Lock Function prevents unexpected start of screwdrivers
- Desktop or wall-hung installation is available
- Input voltage range from 100 V AC to 240 V AC is acceptable in any part of the world

Specifications

Model	DLR5640-WN
Count	1 - 99
Counting Method	Count-up / Count-down
Count Correction Function	Count normal fastening only
Self Adjustable Timer Setting	0.01 to 0.99 sec.
Work Detection Function	Yes (1 terminal) / No
External Count Input	2 terminals (PARTS A / PARTS B)
Work Installation Timer Setting	0 to 9.5 sec.
OK Output Timer Setting	0 to 9.5 sec.
NG Alarm	ON(1) / ON(2) / OFF
OK Buzzer	ON(1) / ON(2) / ON(3) / OFF
Count Return Function	ON / OFF
NG Judge Timing	WORK SET / DRIVER ON
Automatic / Manual OK Judge	AUTO / MANUAL
Screwdriver Lock Function	ON / OFF
Multiple Link	Up to 10 counters can be connected.
External Inputs on Terminal Block	SENSOR / RESET / LINK-IN / PARTS A / PARTS B
External Outputs on Terminal Block	OK / NG / LINK-OUT
Parameter Memory	Parameters stored in internal nonvolatile memory
Screwdriver Control	SPEED / LINEAR START
Input Voltage	100 - 240 V AC, 50/60 Hz
Screwdriver Power Supply	33 V DC, 1.5 A
External Dimensions (mm [inch])	W101 x D140 x H57 [W3.98" x D5.51" x H2.24"]
Mass (g [lbs])	800 [1.76]
Accessories	2 m Power cord with USA plug Suspension ball (2 pcs.)

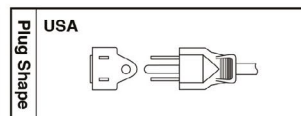

Example of use together with a sensor available in the market



The example of installation

LINK Function (Common to DLR5040A & DLR5640)

When counters are connected and activated in the screw fastening sequence as shown below, all screwdrivers are on standby except the first one in the sequence. Only when the first screw fastening is finished, can the next screwdriver change from standby to ready. When the last fastening in the sequence is finished, the first screwdriver is once again ready and the sequence can be repeated again.
N.B. Up to 10 screwdriver/counter sets can be connected to the LINK.

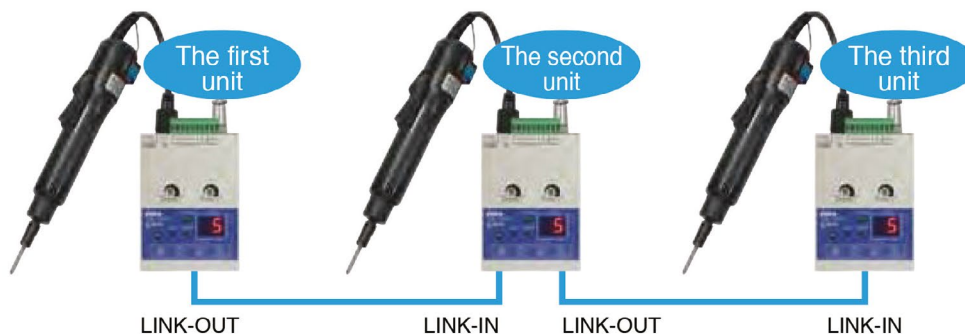

Screwdrivers designed for DLR5640-WN Non-CE



DLV7410A/7410HA/7420A-SPC

DLV7321/7331-SPC

DLR5640-WN



Specifications

Model	DLV7410A-SPC	DLV7410HA-SPC	DLV7420A-SPC	DLV7321-SPC	DLV7331-SPC
Starting Method	Lever Start				
Torque Adjustment	Stepless				
Torque (Nm [lbf-in])	0.02 - 0.2 [0.2 - 1.8]		0.15 - 0.4 [1.3 - 3.5]	0.1 - 0.5 [1.9 - 4.4]	0.3 - 1.2 [2.7 - 10.6]
Free Speed (min ⁻¹)	500 - 750	700 - 1000	450 - 600	300 - 1000	200 - 700
Power Consumption (W)	Approx. 10				
Screw Size (mm)	Machine Screw	1.0 - 2.3	1.6 - 2.6	1.0 - 3.0	2.0 - 3.5
	Tapping Screw	1.0 - 2.0	1.4 - 2.3	1.2 - 2.6	2.0 - 3.0
Electrostatic Countermeasure	Complied with EN100015-1				
Mass (g [lbs])	230 [0.51]			350 [0.77]	
Cord Length (m)	1.5 (with connector)				
Grounding Bit Feature	Equipped as standard				

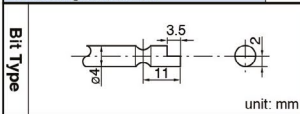

Combinations with Electric Screwdrivers

Screwdriver Model	Connection	Remarks
DLV7410A / 7410HA / 7420A-SPC	The cord comes with screwdriver	Screwdriver for the screw fastening counter only
DLV7321 / 7331-SPC	Direct connection to power source	
DLV7410A / 7410HA / 7420A / 7419A / 7419HA / 7429A-BMN	Optional conversion cord (TD02925 DLW9072)	General-purpose screwdriver *1

*1: The Count Return Function is not available.

Optional Accessories

DLW9072(TD02925)

This minimizes tampering or accidental turning of the torque adjustment ring once the torque is set.

Torque Adjustment Ring Cover
(DLW5700: DLV7400A-SPC
DLW5300: DLV7300-SPC)

Dedicated Screwdrivers for DLR5040A-WE and DLR5340-WE Non-CE

Small



Big

Specifications

		Miniature Screw (1.0 - 3.5 mm)					
Model	Lever Start	DLV7020-SPC	DLV7030-SPC	DLV7031-SPC	-	-	-
	Push to Start	-	-	-	DLV8020-SPC	DLV8030-SPC	DLV8031-SPC
Input Voltage		100 V AC, 50/60 Hz					
Torque Adjustment		Stepless					
Torque	(Nm [lbf-in])	0.05 - 0.55 [0.4 - 4.9]	0.30 - 1.10 [2.7 - 9.7]	0.30 - 1.00 [2.7 - 8.9]	0.10 - 0.55 [0.9 - 4.9]	0.30 - 1.10 [2.7 - 9.7]	0.30 - 1.00 [2.7 - 9.7]
Free Speed	(min ⁻¹)	900	650	1200	900	650	1200
Power Consumption	(W)	Approx. 25		Approx. 30	Approx. 25		Approx. 30
Screw Size	Machine Screw	1.0 - 3.0	2.0 - 3.5	2.0 - 3.0	1.0 - 3.0	2.0 - 3.5	2.0 - 3.0
	Tapping Screw	1.2 - 2.6	2.0 - 3.0		1.2 - 2.6	2.0 - 3.0	
Bit Type		A					
Mass	(g [lbs])	380 [0.84]			390 [0.86]		
Cord Length		3 (with connector)					
Bit Grounding		Equipped as standard					

		Machine Screw(2.6 - 8.0 mm)				
Model	Lever Start	DLV7120-SPC	DLV7130-SPC	DLV7140-SPC	DLV7231-SPC	DLV7241-SPC
	Push to Start	DLV8120-SPC	DLV8130-SPC	DLV8140-SPC	DLV8231-SPC	DLV8241-SPC
Input Voltage		100 V AC, 50/60 Hz *1				
Torque Adjustment		Stepless				
Torque	(Nm [lbf-in])	0.35 - 0.70 [3.10 - 6.20]	0.50 - 1.70 [4.4 - 15.1]	1.20 - 3.00 [10.6 - 26.6]	0.50 - 1.70 [4.4 - 15.1]	1.20 - 3.00 [10.6 - 26.6]
Free Speed	(min ⁻¹)	1000		700	2000	1200
Power Consumption	(W)	35			45	
Screw Size	Machine Screw	2.6 - 3.0	2.6 - 4.0	3.5 - 5.0	2.6 - 4.0	3.5 - 5.0
	Tapping Screw	2.3 - 3.0	2.5 - 3.5	3.0 - 4.0	2.5 - 3.5	3.0 - 4.0
Bit Type		B *2				
Mass	(g [lbs])	710 [1.57] (7100series) / 670 [1.48] (8100series)			710 [1.57] (7200series) / 670 [1.48] (8200series)	
Cord Length		3 (with connector)				
Bit Grounding		Equipped as standard				

		Machine Screw(2.6 - 8.0 mm)	
Model	Lever Start	-	DLV7251-SPC
	Push to Start	DLV8150-SPC	DLV8251-SPC
Input Voltage		100 V AC, 50/60 Hz *1	
Torque Adjustment		Stepless	
Torque	(Nm [lbf-in])	2.0 - 4.5 [17.7 - 39.8]	
Free Speed	(min ⁻¹)	450	700
Power Consumption	(W)	45	
Screw Size	Machine Screw	4.5 - 6.0	
	Tapping Screw	4.0 - 5.0	
Bit Type		C	
Mass	(g [lbs])	810 [1.79]	
Cord Length		3 (with connector)	
Bit Grounding		Equipped as standard	

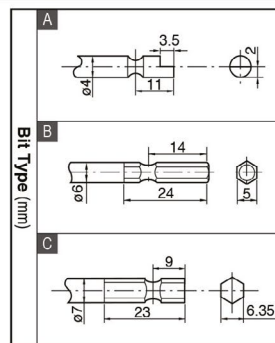

		Machine Screw(2.6 - 8.0 mm)						
Model	Lever Start	DLV30A06L-SPC	DLV30A12L-SPC	DLV30A20L-SPC	DLV45A06L-SPC	DLV45A12L-SPC	DLV70A06L-SPC	
	Push to Start	DLV30A06P-SPC	DLV30A12P-SPC	DLV30A20P-SPC	DLV45A06P-SPC	DLV45A12P-SPC	DLV70A06P-SPC	
Input Voltage		100 V AC, 50/60 Hz *1						
Torque Adjustment		Stepless						
Torque	(Nm [lbf-in])	0.4 - 1.6 / 1.2 - 3.0 [3.5 - 14.2 / 10.6 - 26.6]			2.0 - 4.5 [17.7 - 39.8]		3.8 - 7.0 [33.6 - 62.0]	
Free Speed	(min ⁻¹)	650	1200	2000	650	1200	650	
Power Consumption	(W)	45						
Screw Size	Machine Screw	2.6 - 5.0			4.5 - 6.0		5.0 - 8.0	
	Tapping Screw	2.5 - 4.0			4.0 - 5.0		4.5 - 6.0	
Bit Type		B *2			C			
Mass	(g [lbs])	700 [1.54]			870 [1.92] with pistol grip			
Cord Length		3 (with connector)						
Bit Grounding		Equipped as standard						

*1: Please contact us for other voltage availabilities. *2: Please contact us for 6.35 mm bit type.

Optional Accessories



Torque Adjustment Ring Cover
DLW5200: DLV7100/7200/8100/8200-SPC
DLW5300: DLV7000/8000-SPC

- This minimizes tampering or accidental turning of the torque adjustment ring once the torque is set.
- Flanged coupling DLW9011 can not be mounted on SPC type



Pistol Grip
DLW2300: DLV7100/7200/
8100/8200/30/45/70-SPC

- Suitable for horizontal operation



TD04061 SPC cord for commercial power source (optional)

- Dedicated screwdrivers can be directly plugged in commercial power source.

Transformerless (AC)		
Brush motor	Brushless motor	
Miniature screw	Precision screw	Machine screw
2.6 - 8.0 mm		



delvo Brushless Type

A Series (For Automation) Model DLV30A/45A/70A Non-CE



Features

For automatic assembly robot

- Three series of screwdrivers can be mounted on the XY robot
- Automatic screw tightening achieves a labor-saving or unattended process
- Long-life brushless motors are incorporated in the electric screwdrivers
- Standard coupling, flange coupling, and left-hand thread coupling are available for installation
- The electric screwdriver generates the torque-up signal
- The screwdrivers can be connected to a sequencer to control starting, forward rotation, and reverse rotation
- An electrical noise preventive measure is employed to avoid malfunction. Each input/output signal is insulated from a screwdriver's internal circuit by a photocoupler.

Specifications

		Low Speed	Standard	High Speed	Low Speed	Standard	Low Speed	
Electric Screwdriver	Model: Bit	DLV30A06A-N(AA) : J	DLV30A12A-N(AA) : J	DLV30A20A-N(AA) : J	DLV45A06A-N(AA) : K	DLV45A12A-N(AA) : K	DLV70A06A-N(AA) : K	
		DLV30A06A-F(AA) : J	DLV30A12A-F(AA) : J	DLV30A20A-F(AA) : J	DLV45A06A-F(AA) : K	DLV45A12A-F(AA) : K	DLV70A06A-F(AA) : K	
		DLV30A06A-M(AA) : J	DLV30A12A-M(AA) : J	DLV30A20A-M(AA) : J	DLV45A06A-M(AA) : K	DLV45A12A-M(AA) : K	DLV70A06A-M(AA) : K	
	Input Voltage	100 V AC, 50/60 Hz						
	Torque (Nm [lbf-in])	0.4 - 1.6 [3.5 - 14.2]		2.0 - 4.5 [17.7 - 39.8]		3.8 - 7.0 [33.6 - 62.0]		
		1.2 - 3.0 [10.6 - 26.6]						
	Free Speed (min ⁻¹)	650	1200	2000	650	1200	650	
	Screw Size (mm)	2.6 - 5.0		4.5 - 6.0		5.0 - 8.0		
		2.5 - 4.0		4.0 - 5.0		4.5 - 6.0		
	Mass (g [lbs])	700 [1.54]		780 [1.72]		840 [1.85]		
	760 [1.68]		820 [1.81]					
	740 [1.63]							
Power Consumption (W)	45							
Starting Method	External input signal							
Input signal	Start signal / Forward signal / Reverse signal (5 - 24 V DC)							
Output signal	Torque-up signal (Voltage under 30 V DC and current 20 mA)							
Standard Accessories	• Bit NK31 × 2 × 6 × 70: 1 pc. • Low torque spring: 1 pc.			• Bit NK35 × 2 × 7 × 75: 1 pc.				

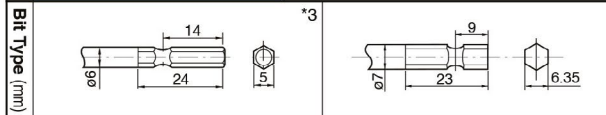

*1: Standard Accessory
 *2: Built-in
 *3: DLV30A is available upon request for use with 6.35 mm hex. shank bits.

Optional Accessories



Torque Diagrams (for reference)

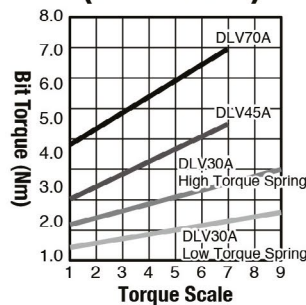

Screwdriver Cable Breakdown List

Power/Input Signal Cable

Color	Details
Green	Power input
Yellow	Power input
Blue	Bit earth
White	Input signal common (Vcc)
Black	Start signal input
Orange	Forward signal input
Gray	Reverse signal input

Power input voltage: 100 V AC

Output Signal Cable

Color	Details
White	Torque-up signal output
Black	Ground

Delvo Brushless Type

Power Input/Output Signal Schematic Diagram

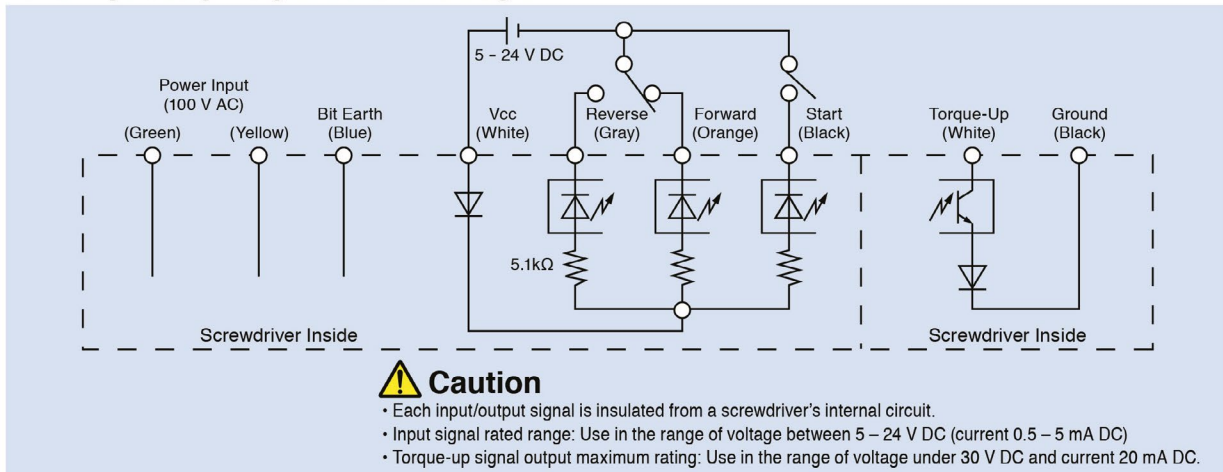

Operation Timing Chart

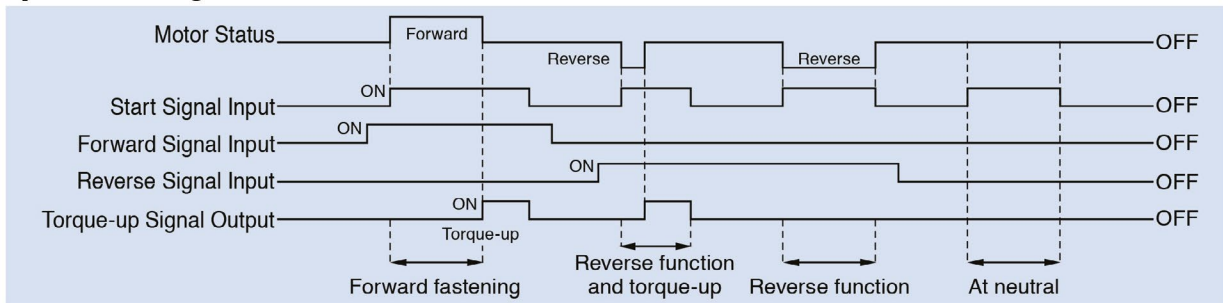

External Dimensions

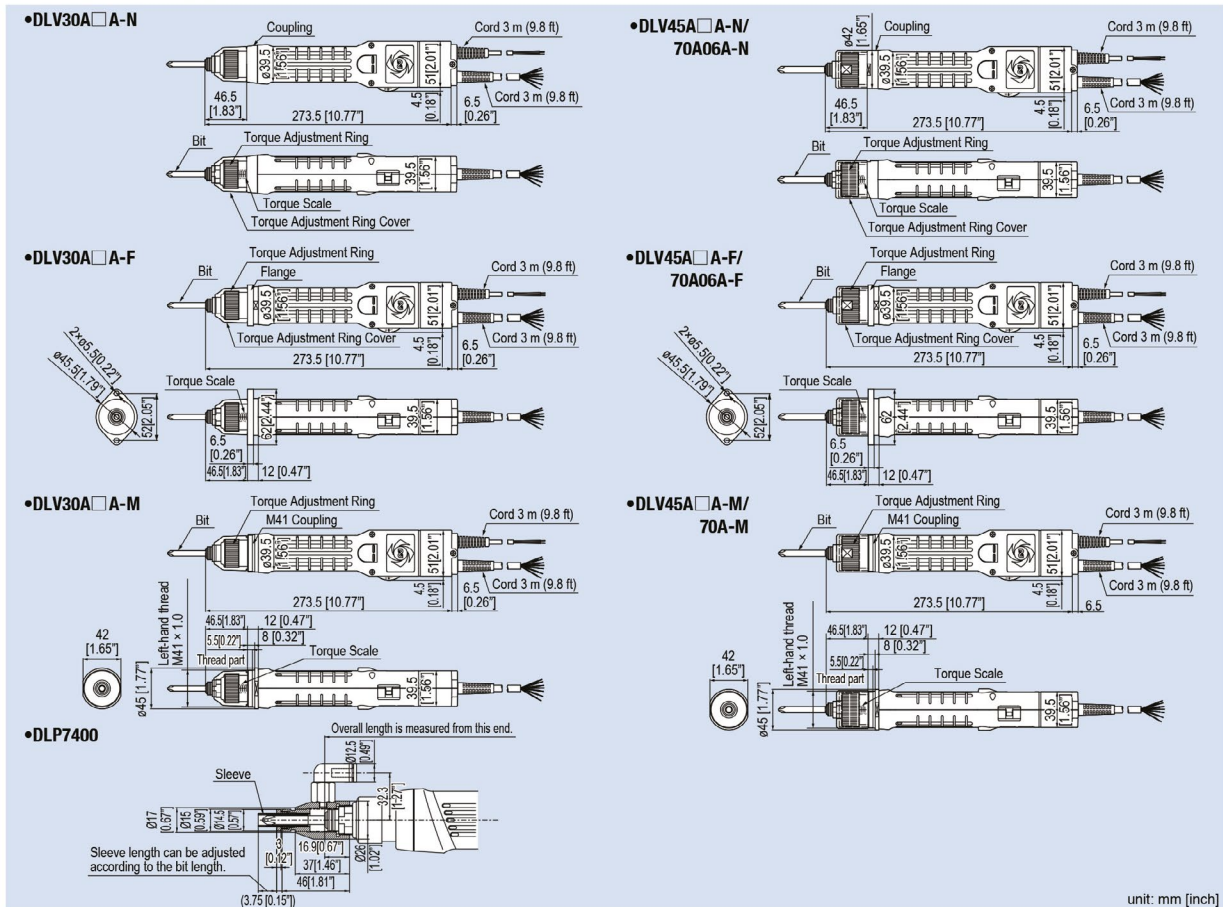

According to Model
 Brush motor Brushless motor
 Miniature screw Precision screw Machine screw
 1.0 - 6.0 mm



DLV3100/3300 Series (For Automation) Non-CE

DLV3100 series DLV3300 series



Features

A Labor-Saving "delvo" for Automatic Assembly Robot

- Vibration-proof and shock-proof for long continuous screw tightening
- Torque-up signal output
- High repetitive torque accuracy

1: Models DLV3121 / 3131 / 3141 / 3151 have no bit-holding function. Please order the following models with bit holding function if required, but they require 100 V AC power source and are made to order products.

- DLV3128-EJN • DLV3138-EJN
- DLV3148-EJN • DLV3158-EJN

NOTE: The bit mounting is made in a specific way.

Specifications

Electric Screwdriver	For Precision Screws		For Machine Screws			
	DLV3321-CMN	DLV3331-CMN	DLV3121-EJN*1	DLV3131-EJN*1	DLV3141-EJN*1	DLV3151-EJN*1
Model						
Input Voltage	36 V DC (supplied from controller)		100 V AC, 50/60 Hz			
Torque Adjustment	Stepless					
Torque (Nm [lbf-in])	0.05 - 0.5 [0.4 - 4.4]	0.3 - 1.2 [2.7 - 10.6]	0.25 - 0.7 [2.2 - 6.2]	0.5 - 1.5 [4.4 - 13.3]	1.2 - 3.0 [10.6 - 26.6]	2.0 - 4.5 [17.7 - 39.8]
Free Speed (min ⁻¹)	900	600	900		600	450
Power Consumption (W)	Approx. 35					
Screw Size (mm)	Machine Screw	2.0 - 3.5	2.3 - 2.6	2.6 - 3.5	3.5 - 5.0	4.5 - 6.0
	Tapping Screw	1.2 - 2.6	2.0 - 3.0	2.3 - 3.0	2.5 - 3.5	3.0 - 4.0
Mass (g [lbs])	400 [0.88]		900 [1.98]			
Standard Accessories	• Cable (2 m): 1 pc. • Spare Carbon Brush: 2 pc.					

* The 2 m cord exclusively for DLV3321/3331 comes with DLC3310 as a standard accessory.

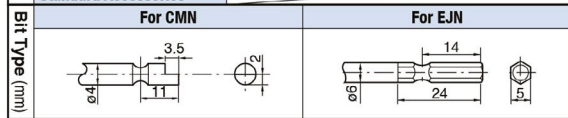

Controller	DLC3310
Model	
Input Voltage	24 V AC, 50/60 Hz
Output Voltage	36 V DC
Mass (g [lbs])	360 [0.79]

Installation Example

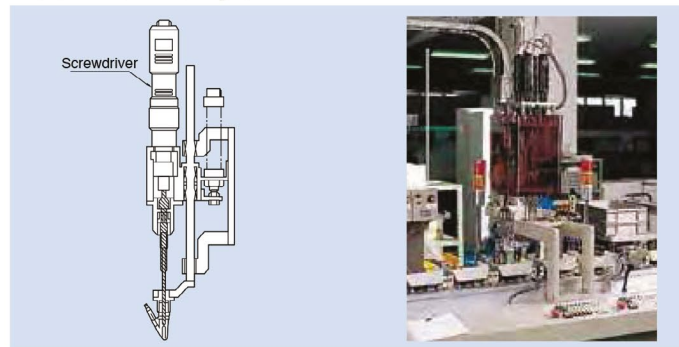

External Dimensions

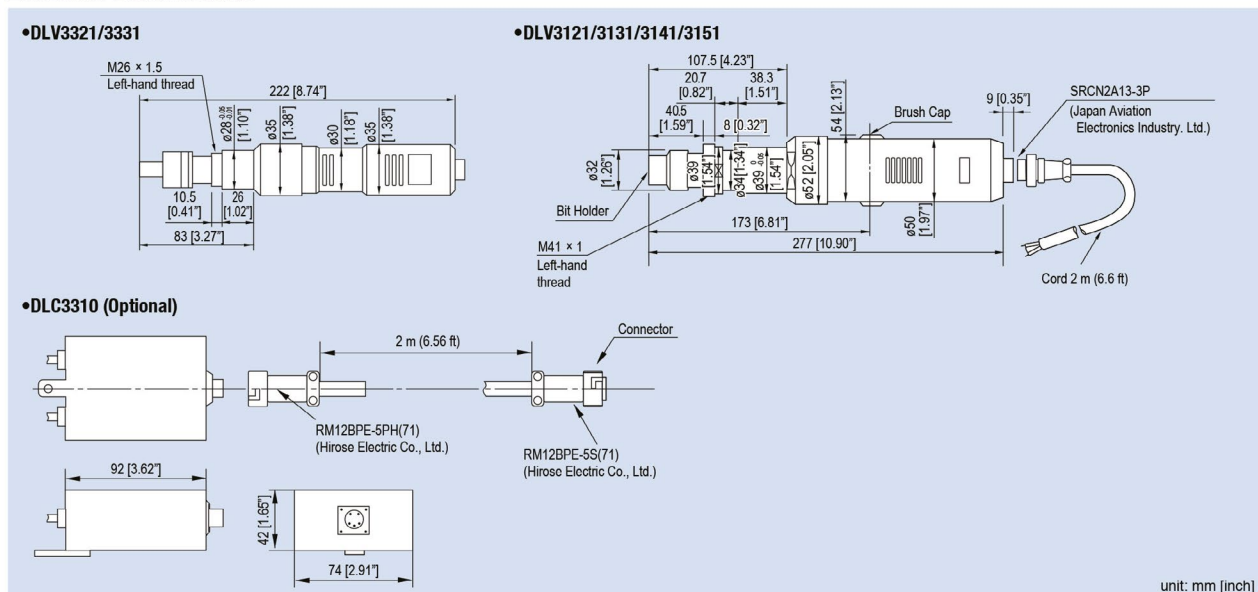

unit: mm [inch]

DLT1173A/1673A/1973A Series

Torque Checker



Features

Maintaining high assembly quality with ease

- Measured data is stored even after the power is turned off, preventing any data loss
- Energy saving type with AUTO POWER OFF function (Power is automatically turned off when left unused for 10 minutes)
- A program designed for uploading the data stored in the "delvo" torque checkers to a computer is available to download free from the NITTO KOHKI website:
www.nitto-kohki.co.jp/e/prd/e-dl/delvo.html



Click

Specifications

Model	DLT1173A	DLT1673A	DLT1973A
Measurement Range (Nm[lbf-in])	0.015 - 1.500 [0.13 - 13.3]	0.15 - 10.00 [13.5 - 88.5]	4.00 - 12.00 [35.4 - 106.2]
Calibration Precision	Within ± 0.5% (Full Scale) For 0.2 Nm [2 lbf-in] or less ± 1 digit	Within ± 0.5% (Full Scale) For 2 Nm [20 lbf-in] or less ± 1 digit	Within ± 0.5% (Full Scale)
Display	4-digit digital display (Single-line)	Data sampling: 1000 times/sec.	Display rate: 12 times/sec.
Measuring Unit	kgf • cm, Nm, lbf • in (selectable)		
Data Memory	800 pieces of data		
Measuring Direction	CW and CCW		
Measuring Mode	3 modes: PD-TR-PP		
Auto Power Off	Power off if left untouched for 10 minutes		
External Output	As per USB output	Mitsutoyo Digimatic	
Analog Output	Approx. 1.5 V max.	Approx. 1.0 V max.	Approx. 1.1 V max.
Continuous Operation Time	No zero offset; identical waveforms produced in PP, PD, and TR modes 20 hours		
External Dimensions (mm) [inch]	W160 × D110 × H47 [W6.3" × D4.33" × H1.85"]		W200 × D112 × H48.5 [W7.9" × D4.41" × H1.89"]
Mass (g [lbs])	1100 [2.43]		1400 [3.09]
Rechargeable Battery	Nickel metal hydride battery		
Charger Type	DLE1833A		
Input Voltage for Charger	100 - 240 V AC, 50/60 Hz		
Charging Time	4 hours		
Standard Accessories	• Screw Joint (DLW4430)	• Bit Joint (DLW4360) • Spring for Joint (DLW4660)	• Soft Joint (DLW4000)

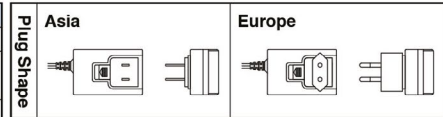

Selection of Torque Checker

DLT1173A	DLT1673A	DLT1973A
DLV3300*2	DLV7100/7200/ 8100/8200	DLV45A/70A
DLV5700		DLV45S/70S
DLV5800	DLV7500/8500	DLV45A/70A (automation)
DLV7300	DLV3100*3	
DLV7000/8000	DLV30A/45A	
DLV7400A	DLV30S/45S	
DLV02/12	DLV16	
DLV04C/10C	DLV7104/8104/8204	
	DLV30A/45A (automation)	

*2: A reversible screwdriver is required to loosen the measuring joint.

*3: A reversible screwdriver is required to loosen the measuring joint. Screw joint is required.

Optional Accessories

	Model	Part No.	Shape	Torque Range	DLT1173A	DLT1673A	DLT1973A
Bit Joint	DLW4330	TD03305	OD 4 mm [0.16"] type	0.015 - 0.25 Nm [0.13 - 2.2 lbf-in]	○	—	—
	DLW4340	TD03306	OD 4 mm [0.16"] type	0.15 - 1.5 Nm [1.3 - 13.3 lbf-in]	○	○	—
	DLW4350	TD03307	Hex 5 [0.2"] and Hex 6.35 [1/4"] types	0.15 - 1.5 Nm [1.3 - 13.3 lbf-in]	○	○	—
	DLW4360	TD03308	Hex 5 [0.2"] and Hex 6.35 [1/4"] types	0.15 - 6.5 Nm [1.3 - 57.5 lbf-in]	—	◎	—
Screw Joint	DLW4430	TD03309	screw type (Bit size No.2)	0.15 - 1.5 Nm [1.3 - 13.3 lbf-in]	◎	○	—
	DLW4530*1	TD03310	screw type (Bit size No.2)	0.15 - 5 Nm [1.3 - 44.3 lbf-in]	—	○	—
Soft Joint	DLW4000	TD04123	Hex 13 [0.51"] type	4.0 - 12.0 Nm [35.4 - 106.2 lbf-in]	—	○	◎
Hard Joint	DLW4040	TD04124	(Hex. head bolt)		—	—	○
Spring	DLW4660	TV03826	Spring for DLW4340, 4350, 4430	—	◎	—	

*1 DLW4530 must be used at 5 Nm [44.3 lbf-in] or less.

◎: Standard accessories ○: Available as option —: Unsupported

Bit Joint

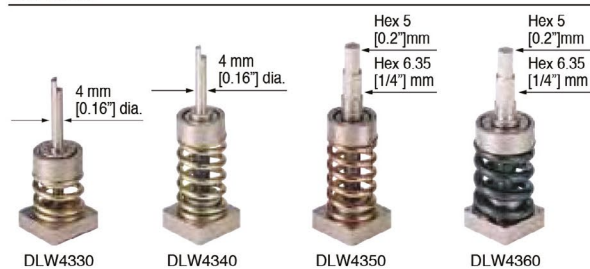

Screw Joint



Soft Joint



Hard Joint



Spring



External Dimensions

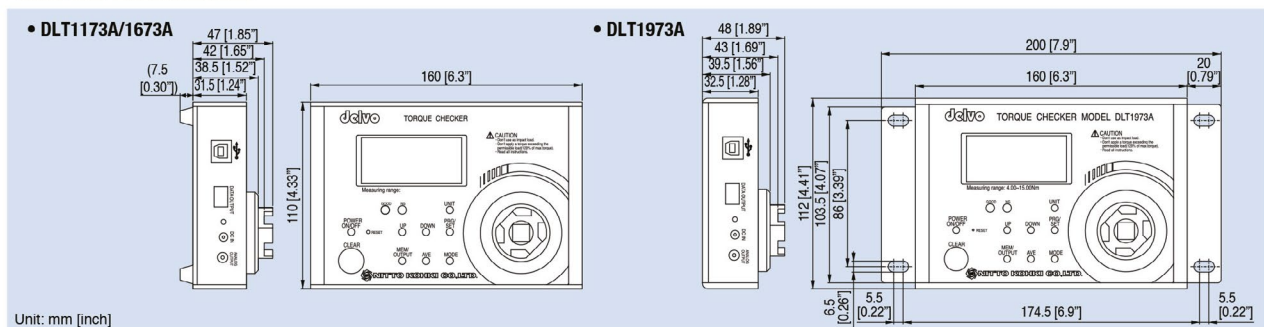

NK BIT

■ For DLV7400A, 5700, 5800, 7300, 7000, 8000, 3300 series

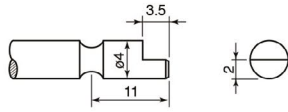

OD 4 mm Shank

Unit: mm

Model	Part No.	Size			Dimensions	
		No.	d	L		
Phillips	NK4D	TD20009	00	2	44	
		TD20010			64	
		TD20021		1.8	44	
		TD20022	0		64	
		TD20029		2.5	44	
		TD20030			64	
		TD20037		3	44	
		TD20038	1		64	
		TD20039		4	44	
		TD20040			64	
		TD20047	2	4	44	
		TD20048			64	
TD20050	3	6	44			
Plain Slot	NK4DM	TD20051	2	0.3	44	
		TD20052	2.5	0.3		
		TD20053	3	0.4		
		TD20054	4	0.5		
		TD20055	5	0.65		
Hexagon Head	NK4DX	TD20056	1.5		44	
		TD20057	2			
		TD20058	2.5			
		TD20059	3			
		TD20060	4			
Hex Socket	NK4DB	TD20064	4	6	44	
		TD20065	4.5	7		
		TD20066	5	7		
		TD20067	5.5	8		

■ For DLV7100, 7200, 8100, 8200, 3100, A(DLV30A) series

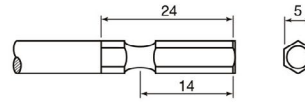

OD 5 mm Hex. Shank

Unit: mm

Model	Part No.	Size			Dimensions		
		No.	d	L			
Phillips	NK31	TD20193	1	4	70		
		TD20194		100			
		TD20196		70			
		TD20197		100			
		TD20200		70			
		TD20201	100				
		TD20210	2	5	70		
		TD20211		100			
		TD20214		70			
		TD20215		100			
TD20215	100						
Phillips	NK16	TD20224	1	70			
		TD20225	100				
		TD20232	70				
		TD20233	2	100			
		TD20235	150				
Hexagon Head	NK31X	TD20254	2	4	70		
		TD20256	2.5		70		
		TD20258	3				
		TD20260	4				
		TD20262	5				
Hex Socket	NK31B	TD20272	5.5	9	4	70	
		TD20274	6	10	4.5	70	
		TD20276	7	11	5.5	70	
		TD20277	8	13	6	70	
		TD20278	8	13	6	100	
		TD20279	8	13	6	70	
		TD20282	10	16	8	70	
		TD20283	10	16	8	100	

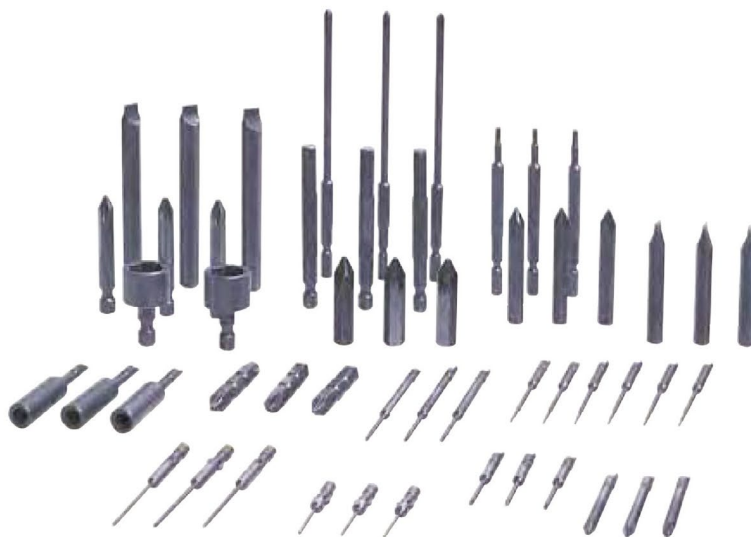

NK BIT

■ For DLV7500, 8500, 7100, 7200, 8100, 8200,
02, 12, 16, A(DLV30A/45A/70A) series

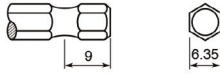

OD 6.35 mm Hex. Shank

Unit: mm

Model	Part No.	Size		Dimensions	
		No. x	d x L		
Phillips	NK35	TD20306	1	4 x 75	
		TD20307		4 x 100	
		TD20308		50	
		TD20309		75	
		TD20310		100	
		TD20311		120	
		TD20312	150		
		TD20313	200		
		TD20319	50		
		TD20320	75		
		TD20321	100		
		TD20322	120		
		TD20323	150		
		TD20324	200		
		TD20327	50		
		TD20328	75		
TD20329	100				
TD20330	120				
TD20331	150				
TD20332	200				
Model	Part No.	No. x	d x L	Dimensions	
Phillips	NK36	TD20335	0	3.8 x 50	
		TD20336	1		
		TD20337	2		
		TD20338	4.5		
Model	Part No.	No. x	L	Dimensions	
Phillips	NK15	TD20354	1	50	
		TD20355		75	
		TD20356		100	
		TD20357		120	
		TD20358		150	
		TD20359		200	
		TD20362	50		
		TD20363	75		
		TD20364	100		
		TD20366	150		
		TD20367	200		
		TD20371	75		
TD20372	100				
TD20374	150				
TD20375	200				
Model	Part No.	W x T x L	Dimensions		
Plain Slot	NK35M	TD20378	7 x 0.9 x 50		
		TD20379			75
		TD20380			100
Model	Part No.	H x d x L	Dimensions		
Hexagon Head	NK35X	TD20382	1.27	3 x 70	
		TD20385	1.5		
		TD20388	2		
		Part No.	H x L		
		TD20391	2.5		
		TD20394	3		
		TD20397	4		
		TD20400	5		
		TD20404	6		
			50		
Model	Part No.	H x D x d x L	Dimensions		
Hex Socket	NK35BN	TD20442	10 x 16 x 8	75	
		TD20443	100		
		TD20457	75		
		TD20458	100		

If Bits other than the above are required,
please contact Nitto Kohki or our distributors.

Vacuum Pickups and Sleeves

Screwdriver series	Vacuum Pickup			Sleeve (Standard accessory)	
	Type	Model	Part No.	Model	
DLV7000/DLV8000/DLV3300	Type A	DLP6500	TD00343	DLS2124/DLS2127/DLS2130	
DLV7400A/DLV5700/DLV5800		DLP5300	TD04342	DLS2120/DLS2124	
DLV7313	Type B	DLP7100	TD00345	DLS2122/DLS2124/DLS2127	
DLV7323/DLV7333		DLP7200	TD00346	DLS2123/DLS2124/DLS2127	
		DLP7300	TD00347	DLS2135	
		DLP7000	TD00344	DLS3223/DLS3225	
DLV7100/DLV7200/DLV8100/DLV8200	Type C	DLP7400	TD07285-0	DLS3223/DLS3225	
DLV7104/DLV8104/DLV8204		DLP7400 for High Torque	TD07286-0	DLS4220/DLS4221	
delvo Brushless Type A series 30A		DLP6600/DLP6610	TD08748/TD08751	DLS2124/DLS2127/DLS2134	
delvo Brushless Type S series 30S	Type D	DLP6640/DLP6650	TD08804/TD08805	DLS4225/DLS4227	
delvo Brushless Type A series 45A/75A					
delvo Brushless Type S series 45S/75S					
delvo Brushless Type C series					

Type	Type A	Type B	Type C	Type D			
Vacuum Pickup							
Sleeve							

DLS2000 series

Model	Part No.	Sleeve		øD		Bit (No. × d × L) (+)
		mm	inch	mm	inch	
DLS2120	TD00348	2	0.08	3.5	0.14	No. 0 × 1.8 × 44
DLS2121	TD00349	2.2	0.09			
DLS2122	TD00350	2.5	0.1			
DLS2123	TD00351	2.7	0.11			
DLS2124	TD00352	3.1	0.12	4.5	0.18	No. 0 × 2.5 × 44
DLS2125	TD00353	3.3	0.13			
DLS2126	TD00354	3.5	0.14			
DLS2127	TD00355	3.7	0.15			
DLS2128	TD00356	4	0.16	5.5	0.22	No. 1 × 3 × 44
DLS2129	TD00357	4.2	0.17			
DLS2130	TD00358	4.5	0.18			
DLS2131	TD00359	4.7	0.19			
DLS2132	TD00360	5.1	0.2	6.5	0.26	No. 2 × 4 × 44
DLS2133	TD00361	5.3	0.21			
DLS2134	TD00362	5.6	0.22			
DLS2135	TD00363	6.1	0.24			

DLS3000 series

Model	Part No.	Sleeve		øD		ø		L		Bit (No. × d × L) (+)
		mm	inch	mm	inch	mm	inch	mm	inch	
DLS3222	TD00364	5.6	0.22	7	0.28	5	0.2	34	1.34	No. 1 × 5 × 70
DLS3223	TD05024	6.1	0.24	9	0.35	/				
DLS3224	TD00365	6.4	0.25							
DLS3225	TD00366	7.1	0.28	7	0.28	18	0.71	65	2.56	No. 2 × 6 × 70
DLS3226	TD00367	4.6	0.18							
DLS3227	TD00368	5.1	0.2	9	0.35	/				
DLS3228	TD00369	5.6	0.22							
DLS3229	TD00370	6.1	0.24	7	0.28	/				
DLS3230	TD00371	6.4	0.25							
DLS3231	TD00372	7.1	0.28							

DLS4000 series

Model	Part No.	Sleeve		øD		ø		L		Bit (No. × d × L) (+)
		mm	inch	mm	inch	mm	inch	mm	inch	
DLS4220	TD08001	9.1	0.36	11	0.43	5	0.2	6	0.24	No. 2 × 7 × 75
DLS4221	TD08002	10.6	0.42	12.5	0.49	5.5	0.22	7	0.28	
DLS4225	TD09344	4.6	0.18	7	0.28	/		/		
DLS4227	TD09345	5.6	0.22							

Accessories

Tool Balancer



Easy to adjust tension by using handle.

Model	TW-06R	TW-1R	RW-3	RW-5
Capacity (g [lbs])	200 - 600 [0.44 - 1.32]	500 - 1500 [1.1 - 3.31]	1000 - 3000 [2.2 - 6.61]	2500 - 5000 [5.51 - 11.02]
Stroke (m [inch])	1.5 [5.9"]		2 [7.8.7"]	
Mass (g [lbs])	300 [0.66]		700 [1.54]	900 [1.98]

Vacuum Pump DLP2500 series



Electric Screwdrivers can be used with Vacuum Pump and Vacuum Pickup. The sleeve of Vacuum Pickup sucks the screw and holds it on the bit, enabling the operator to pick it up with the tool itself, thus improving operational efficiency and operator's productivity.

Model	DLP2530	DLP2570
Features	Standard	With CE mark
Voltage	100 V AC, 50/60 Hz	230 V AC, 50/60 Hz
Power Consumption (W)	30(50 Hz), 26(60 Hz)	
Achievable Vacuum (kPa)	-21.3	
Flow Rate (at Outlet) (L/min)	24(50 Hz), 26(60 Hz)	
Screw Size (mm)	4 or less	
Mass (g [lbs])	3800 [8.38]	

Pistol Grip DLW2300/2300ESD

(for DLV7100, 7200, 8100, 8200, 7500, 8500, 30/45/70-IKE and A(DLV30A/45A/70A) series Electric Screwdrivers)



Easy-to-attach grip suitable for horizontal operation.

Shaker Box Made of Anti-electrostatic Resin

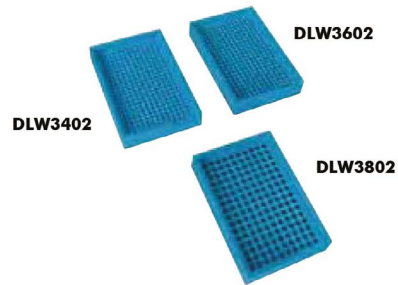

The screws will fall into the heads-up position for easier vacuum or magnetic pickup.

The anti-electrostatic resin greatly reduces static build-up and dust attached to the shaker box.

Model	DLW3402	DLW3602	DLW3802
Part No.	TD04110	TD04111	TD04112
Hole Pitch (mm [inch])	6 [0.24"]		8 [0.31"]
Hole Depth (mm [inch])	13.5 [0.53"]		
No. of Holes	273	273	160
Screw Size (mm)	1.7 - 2	2 - 2.6	3 - 4

Torque Adjustment Ring Cover



Fits over torque adjustment cover to minimize tampering or accidental turning once the torque is set.

Model	Part No.	Applicable Screwdriver
DLW5200	TD00331	DLV7100, 7200, 8100 and 8200 series
DLW5201*1	TD05639	DLV7100, 7200, 8100 series and DLV30A
DLW5202	TD08486	DLV45S/70S and DLV45A/70A
DLW5203	TD09222	DLV30S and DLV30A
DLW5300	TD00332	DLV7301, 7000, 8000 series (for 4 mm bit)
DLW5400	TD01883	DLV7301 series (for 6.35 mm bit)
DLW5500	TD00333	DLV7303 series (for 4 mm & 6.35 mm bit)
DLW5600	TD00334	DLV7500, 8500 series
DLW5700	TD02875	DLV5700, 5800, 7400A series
-	TV07315	DLV02/12/16SL-BKE series
-	TV06787	DLV02/12/16SL-CKE series

*1: As this is a clear plastic cover, torque scale can be seen even after mounted on the screwdriver.

Flanged Coupling DLW9011

(for DLV7100, 7200, 8100, and 8200 series Electric Screwdrivers)

*Can not be mounted on SPC type



Provides a flange which enables the operator to apply axial pressure through the heel of the hand.

Accessories

Torque Reaction Arm

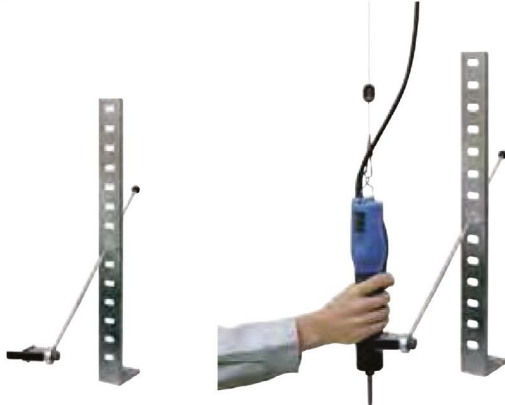

Usage Example

For enhanced productivity and prevention of operator's repetitive motion injury, a torque reaction arm should be used all together.

Part No.	Description	Applicable Screwdriver
TD06180	Torque Reaction Arm	A series(DLV30A/45A/70A) S series(DLV30S/45S/70S)

Optional Cord

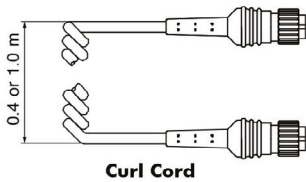

Curl Cord

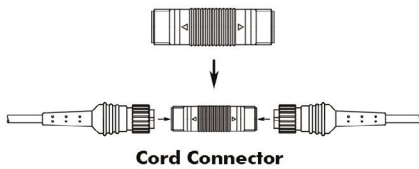

Cord Connector

Please inquire of the distributor for the price and minimum quantity on each optional cord.

Part No.	Optional Cord	Applied Models	Length (m)
TD02826	5P to 6P Exchange Cord**	DLV7300 series	0.1
TD02548	Extension Cord For 5P		3.0
TD03159	Extension Cord For 6P		2.0
TD01882	Curl Cord	DLV7500/8500 series	0.4
TD02820	Curl Cord		1.0
TD02438	Cord Connector DLW9100		

**1: "5P to 6P Exchange Cord" is used to connect "5-prong Screwdriver" to "6-prong Controller".



www.interelectronic.com

1222 Budapest, Gyár St 15.
Phone: +36 1 225-74-15
Phone/Fax: +36 1 207-37-26
E-mail: info@interelectronic.com